

ASPÖCK® E M S



VERKABELUNGEN UND VERTEILER

Vorgefertigte Lichtanlagen sind unsere Stärke. In diesem Kapitel finden Sie alle Informationen zu den Kabeln, Verteilerboxen, Zuleitungen und Adaptern. Zusammengefasst: Zu den wichtigsten Komponenten, um unsere hochwertigen Leuchten erstrahlen zu lassen.

Unser breites Sortiment an Standard-Verkabelungssystemen für alle Segmente, stehen Ihnen ab Lager zur Verfügung. Zur Anbindung der Leitungen an die verschiedenen Systemkomponenten, bieten wir Ihnen zusätzlich eine Fülle an verfügbaren Stecker-systemen und Verteilerboxen an.

WIRING AND JUNCTION BOXES

Pre-manufactured lighting systems are our strength. In this chapter you will find all the information about cables, junction boxes, the supply lines and adapters. In summary: Among the most important components to let our high-quality lamps shine.

Our wide range of standard wiring systems for all segments, are available from stock. To connect the cables to the various system components, we also offer you a wealth of available connector systems and junction boxes.

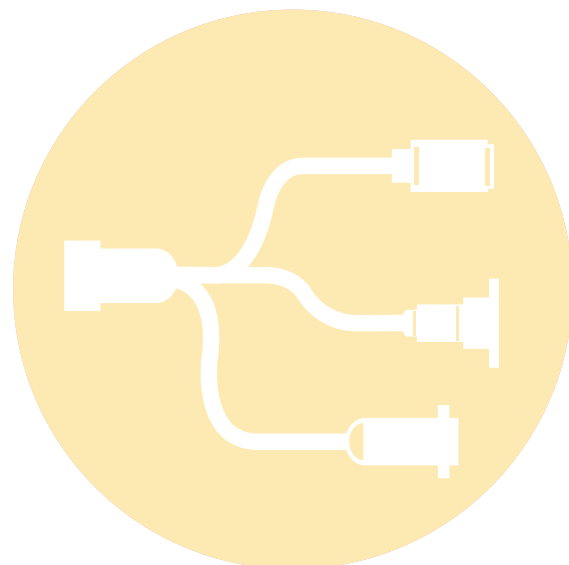



STECKDOSENVERTEILER / SOCKET JUNCTION BOX



[A]

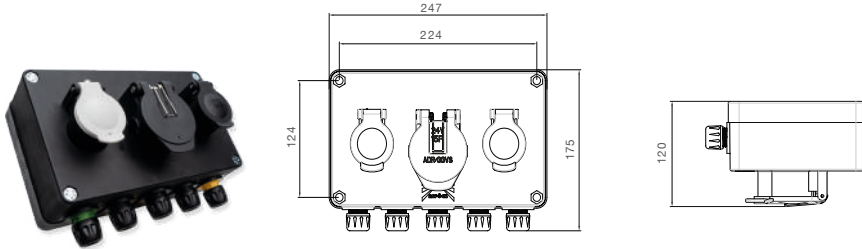

[B]

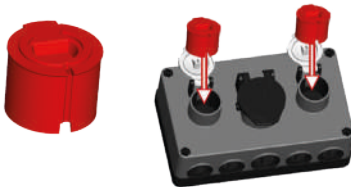

[C]

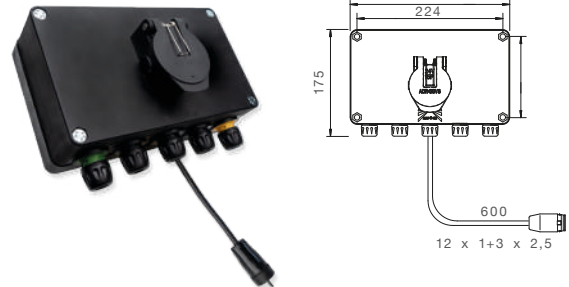

BEST. NR			BESCHREIBUNG	KABEL	ANSCHLUSS					
PART NO		V	DESCRIPTION	CABLE	CONNECTOR					
76-7037-001	1/5	24V		12 x 1,00 mm ² + 3 x 2,5 mm ²	15 pol. ISO 12098 15 pin ISO 12098			0,60 m		
					7 pol. ISO 1185 7 pin ISO 1185					
					7 pol. ISO 3731 7 pin ISO 3731					
					15 pol. ASS3 15 pin ASS3					
76-7069-001	1/6	24V		[A]	15 pol. ISO 12098 15 pin ISO 12098					
					7 pol. ISO 1185 7 pin ISO 1185					
					7 pol. ISO 3731 7 pin ISO 3731					
					17 pol. ASS3 17 pin ASS3					
15-5280-154	1/200	24V	2 Stk. ADR Sicherheitsverschlusskappen für die Steckdosen ISO 1185 und ISO 3731 2 pieces ADR safety caps for sockets ISO 1185 and ISO 3731	[B]						
76-7072-001	1/5	24V		[C]	12 x 1,00 mm ² + 3 x 2,5 mm ²	15 pol. ISO 12098 15 pin ISO 12098			0,60 m	
						17 pol. ASS3 17 pin ASS3				



STECKDOSENVERTEILER SOCKET JUNCTION BOX

ZUBEHÖR / ACCESSORIES

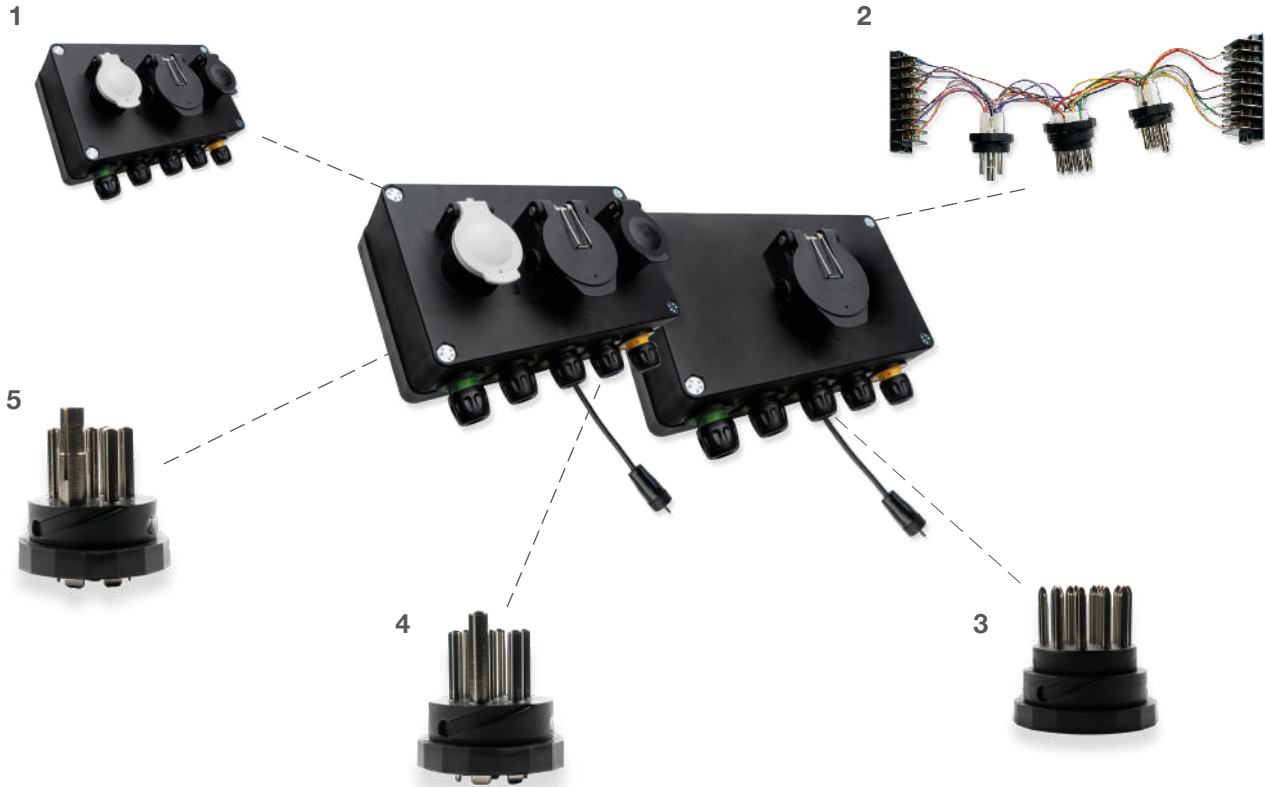

1 Vorverkabeltes Ersatzteil für die Selbstmontage | Pre-wired spare part for self-assembly
..... 76-7001-001

2 Kabelsatz komplett verkabelt mit Steckleiste und Einsätze | Cable set completely wired with connector strip and inserts
..... 58-3008-001

3 15 pol. Steckesatz ISO 12098 | 15 pin plug-in insert ISO 12098
..... 69-0001-004

4 7 pol. Steckesatz ISO 1185 | 7 pin plug-in insert ISO 1185
..... 69-0002-004

5 7 pol. teckeinsatz ISO 3731 | 7 pin plug-in insert ISO 3731
..... 69-0003-004

*** So wird der 3-Fach Steckdosenverteiler für ADR Zone 2 zulässig:**

Um den Steckdosenverteiler für ADR Fahrten zulässig zu machen, müssen Sie bei den Steckdosen ISO 1185 und ISO 3731 die ADR Sicherheitsverschlusskappen verwenden.

This makes the 3-socket junction box permissible for ADR Zone 2:

To make the socket distributor compatible with ADR travel, you must use the ADR safety caps for the ISO 1185 and ISO 3731 sockets.



ZULEITUNGEN / FEED LINES

[A]

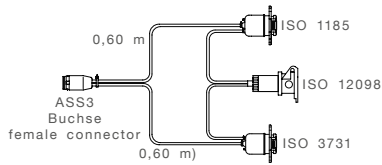

[B]

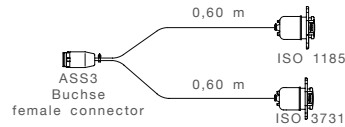

[C]

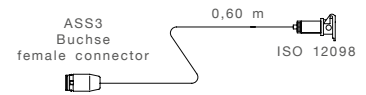

BEST. NR PART NO		V	ZUSATZ ADD ON	ANSCHLUSS CONNECTOR				
58-6647-001	1/5	24V	[A]	7 pol. ISO 1185 7 pin ISO 1185			0,80 m	
				7 pol. ISO 3731 7 pin ISO 3731				
				17 pol. ISO 12098 17 pin ISO 12098				
				17 pol. ASS3 17 pin ASS3				
58-6649-004	1/5	24V	[B]	17 pol. ASS3 17 pin ASS3			0,60 m	
				7 pol. ISO 1185 7 pin ISO 1185				
				7 pol. ISO 3731 7 pin ISO 3731				
53-6768-004	1/25	24V	[C]	17 pol. ASS3 17 pol. ASS3			0,60 m	
				17 pol. ISO 12098 17 pin ISO 12098				



ZULEITUNGEN / FEED LINES

[D]

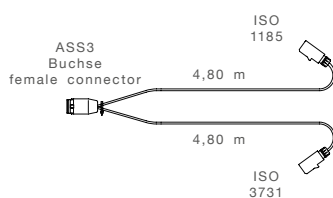

[E]



BEST. NR		V	ZUSATZ	ANSCHLUSS					
PART NO			ADD ON	CONNECTOR					
58-6024-014	1/25	24V		[D]	17 pol. ASS3 17 pin ASS3	♀			
					7 pol. ISO 1185 7 pin ISO 1185	♀		4,80 m	
					7 pol. ISO 3731 7 pin ISO 3731	♀			
53-1667-034	1/10	24V		[E]	17 pol. ASS3 17 pol. ASS3	♀		4,80 m	
					17 pol. ISO 12098 17 pol. ISO 12098	♀			



HAUPTKABEL / MAIN CABLES

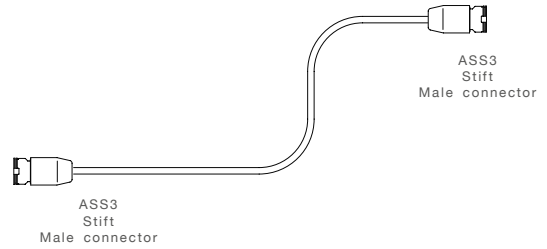

BEST. NR		24V	KABEL	ANSCHLUSS				
PART NO			CABLE	CONNECTOR				
65-1003-004	1/-	24V	6 x 1,00 mm ² + 2 x 2,50 mm ²	2 x 17 pol. ASS3 2 x 17 pin ASS3			9,00 m	
65-1003-014	1/5	24V	6 x 1,00 mm ² + 2 x 2,50 mm ²	2 x 17 pol. ASS3 2 x 17 pin ASS3			12,50 m	
65-1003-021	1/-	24V	6 x 1,00 mm ² + 2 x 2,50 mm ²	2 x 17 pol. ASS3 2 x 17 pin ASS3			15,00 m	
65-1005-004	1/-	24V	7 x 1,00 mm ² + 1 x 1,50 mm ² + 2 x 2,50 mm ²	2 x 17 pol. ASS3 2 x 17 pin ASS3			9,00 m	
65-1005-011	1/-	24V	7 x 1,00 mm ² + 1 x 1,50 mm ² + 2 x 2,50 mm ²	2 x 17 pol. ASS3 2 x 17 pin ASS3			12,50 m	
65-1005-024	1/-	24V	7 x 1,00 mm ² + 1 x 1,50 mm ² + 2 x 2,50 mm ²	2 x 17 pol. ASS3 2 x 17 pin ASS3			15,00 m	
65-1007-004	1/-	24V	12 x 1,00 mm ² + 3 x 2,50 mm ²	2 x 17 pol. ASS3 2 x 17 pin ASS3			9,00 m	
65-1007-014	1/3	24V	12 x 1,00 mm ² + 3 x 2,50 mm ²	2 x 17 pol. ASS3 2 x 17 pin ASS3			12,50 m	
65-1007-024	1/3	24V	12 x 1,00 mm ² + 3 x 2,50 mm ²	2 x 17 pol. ASS3 2 x 17 pin ASS3			15,00 m	



VERTEILERBOX ASS1 / JUNCTION BOX ASS1

IP 54

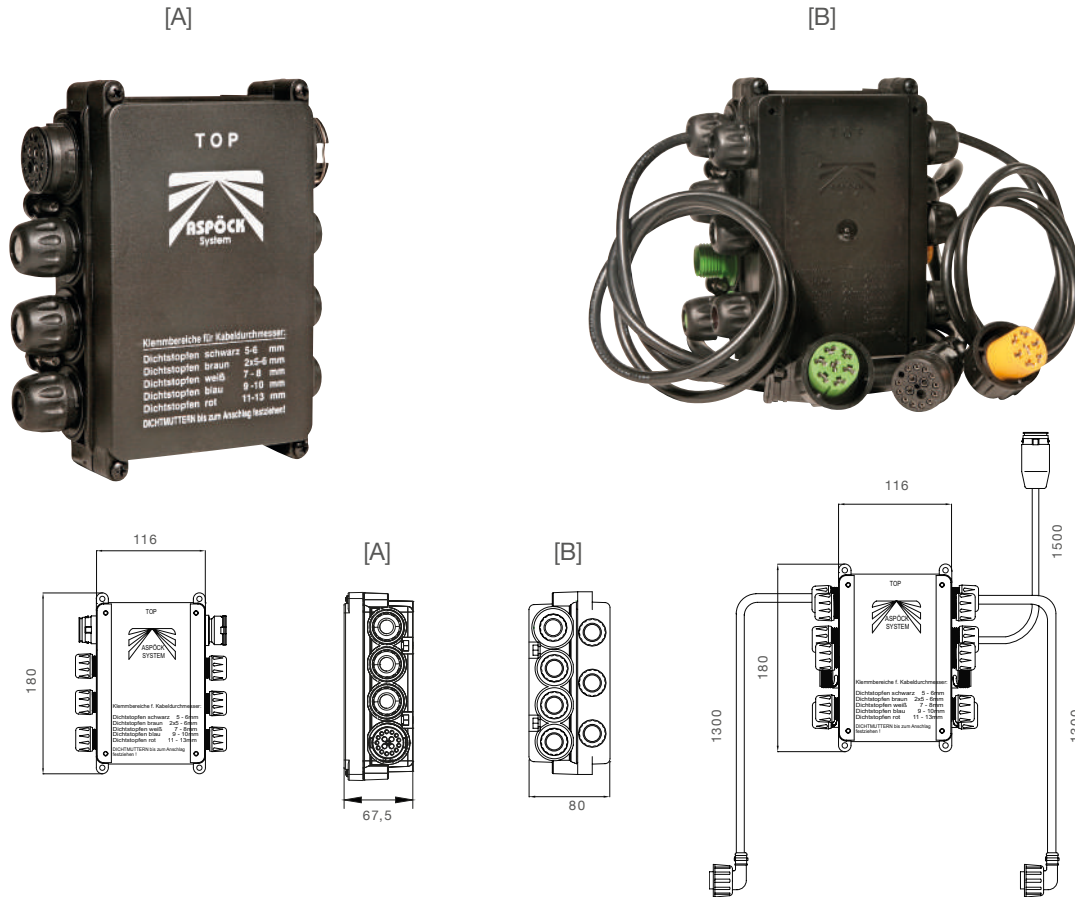

BEST. NR			ZUSATZ	ANSCHLUSS				
PART NO		V	ADD ON	CONNECTOR				
76-6430-001	1/1	24V		B	2 x 7 pol. ASS2 2 x 7 pin ASS2	 	1,30 m	
					17 pol. ASS3 17 pin ASS3	 	1,50 m	
76-5123-001	1/-	24V		A	17 pol. ASS3 17 pin ASS3			
					17 pol. ASS3 17 pin ASS3	 		
76-5123-111	1/-	24V		A	17 pol. ASS3 17 pin ASS3	 		
					17 pol. ASS3 17 pin ASS3	 		
					2 pol. ASS2 2 pin ASS2	 		



VERTEILERBOX ASS1 JUNCTION BOX ASS1

ZUBEHÖR / ACCESSORIES

IP 54

1

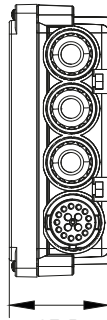

67,5

2

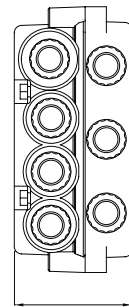

80

1 Verteilerbox mit hohem Deckel |
Junction box with high cap
..... 76-5100-001 

2 Verteilerbox mit niederem Deckel |
Junction box with low cap
..... 76-5100-041 









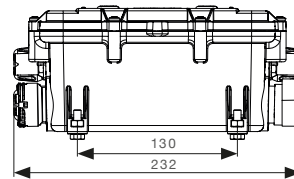
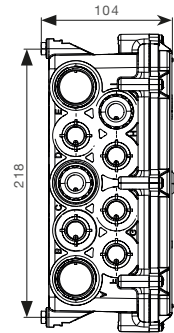
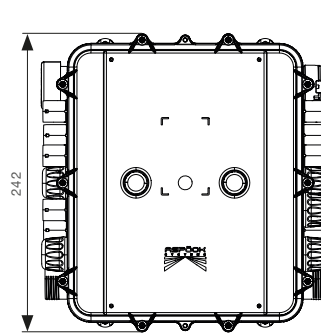

VERTEILERBOX XL / JUNCTION BOX XL

IP 56K

ADR
Zone 2



BEST. NR			BESCHREIBUNG	ANSCHLUSS			
PART NO			DESCRIPTION	CONNECTOR			
76-5203-001	1/-	24V	Verteilerbox XL Junction box XL	17 pol. ASS3 17 pin ASS3	  		
				17 pol. ASS3 17 pin ASS3	  		



VERKABELUNG SML / SML WIRING

[A]

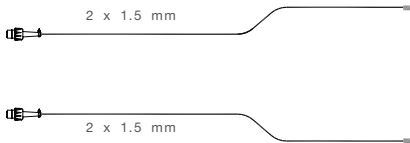

[B]

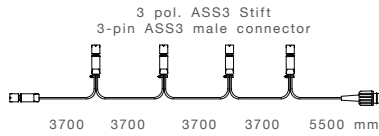

[C]

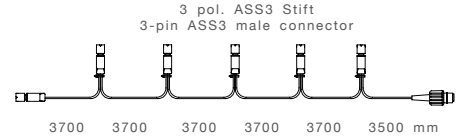

BEST. NR			BESCHREIBUNG	KABEL		ANSCHLUSS					
PART NO		V	DESCRIPTION	CABLE		CONNECTOR					
68-7503-041	1/-	24V	P&R Flachkabel Kabelmarkierung weiß	2 x 1,50 mm ²	[A]	2 pol. ASS2 2 pin ASS2				10,00 m	
68-7503-004	1/-	24V	P&R flat cable cable marking white			2 pol. ASS2 2 pin ASS2				13,00 m	
68-7502-361	1/-	24V	P&R Flachkabel Kabelmarkierung gelb/grün P&R flat cable cable marking yellow/green			2 pol. ASS2 2 pin ASS2				13,00 m	
68-7503-011	1/5	24V				2 pol. ASS2 2 pin ASS2				15,00 m	
68-7503-174	1/-	24V	P&R Flachkabel Kabelmarkierung weiß P&R flat cable cable marking white			2 pol. ASS2 2 pin ASS2				16,00 m	
68-7503-021	1/5	24V				2 pol. ASS2 2 pin ASS2				17,00 m	
68-7502-371	1/-	24V	P&R Flachkabel Kabelmarkierung gelb/grün P&R flat cable cable marking yellow/green			2 pol. ASS2 2 pin ASS2				17,00 m	
87-1284-004	1/5	24V		2 x 1,00 mm ²	[B]	2 pol. ASS2 2 pin ASS2				5,50 m	
						5 x 2 pol. ASS3 5 x 2 pin ASS3				3,70 m	
87-1285-004	1/-	24V		2 x 1,00 mm ²	[C]	2 pol. ASS2 2 pin ASS2				3,50 m	
						6 x 2 pol. ASS3 6 x 2 pin ASS3				3,70 m	



VERTEILERLEITUNG HINTEN / REAR SUPPLY HARNESS

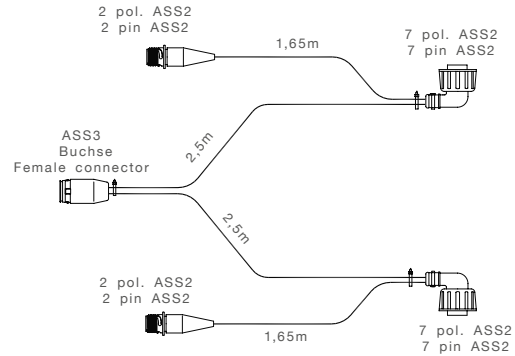

BEST. NR PART NO		24V	BESCHREIBUNG DESCRIPTION	ZUSATZ ADD ON	KABEL CABLE	ANSCHLUSS CONNECTOR				
68-4800-004	1/10	24V			7 x 1,00 mm ²	17 pol. ASS3 17 pin ASS3	♀		2 x 2,50 m	
			2 x 7 pol. ASS2 2 x 7 pin ASS2	♂						
68-4983-004	1/10	24V			7 x 1,00 mm ²	17 pol. ASS3 17 pin ASS3	♀		2 x 2,50 m	
			2 x 7 pol. ASS2 2 x 7 pin ASS2	♀						
			P&R Flachkabel P&R flat cable		2 x 2 x 1,50 mm ²	2 x 2 pol. ASS2 2 x 2 pin ASS2	♂		2 x 1,70 m	
68-4855-001	1/10	24V			2 x 7 x 1,00 mm ²	17 pol. ASS3 17 pin ASS3	♀		2 x 3,00 m	
			2 x 7 pol. ASS2 2 x 7 pin ASS2	♀			1,00 m			
			P&R Flachkabel P&R flat cable		2 x 1,50 mm ²					
68-4888-004	1/10	24V			7 x 1,00 mm ²	17 pol. ASS3 17 pin ASS3	♀		2 x 2,50 m	
			2 x 7 pol. ASS2 2 x 7 pin ASS2	♀						
					2 x 0,75 mm ²	2 x 2 pol. ASS2 2 x 2 pin ASS2	♂		2 x 0,70 m	



ADAPTERKABEL / ADAPTER CABLES

[A]

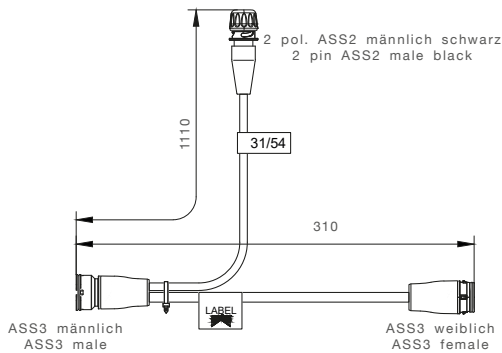

[B]

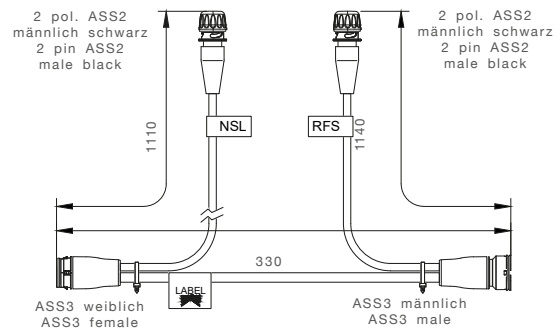

BEST. NR			BESCHREIBUNG	KABEL	ANSCHLUSS
PART NO		V	DESCRIPTION	CABLE	CONNECTOR
66-8892-004	1/-	24V	8 adriges Kabel 8 core cable	6 x 1,00 mm ² 2 x 2,50 mm ²	[A] 17 pol. ASS3 17 pin ASS3
			1 x Abgang Bremsleuchte 1 x outlet stop lamp	3 x 2,50 mm ²	
66-8893-004	1/-	24V	9 adriges Kabel 9 core cable	9 x 1,00 mm ²	[B] 17 pol. ASS3 17 pin ASS3
			2 x Abgang für RFS und NSL 2 x outlet for reverse lamp and fog lamp	2 x 1,00 mm ²	



ADAPTERKABEL / ADAPTER CABLES

[C]

[D]

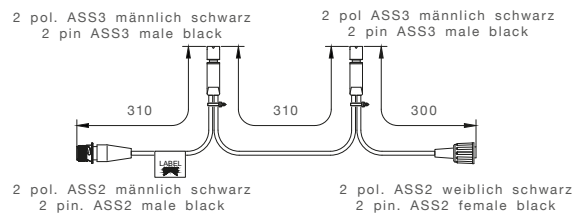
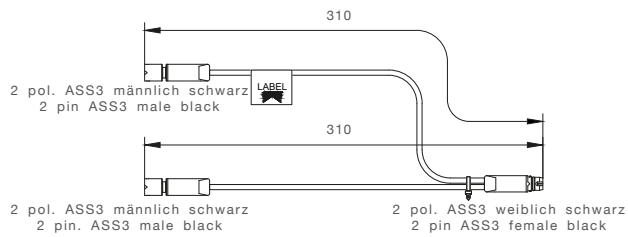

BEST. NR		V	BESCHREIBUNG	KABEL		ANSCHLUSS
PART NO			DESCRIPTION	CABLE		CONNECTOR
65-6499-004	1/-	24V	Y-Kabel Y-cable	2 x 1,00 mm ²	[C]	2 x 2 pol. ASS3 2 x 2 pin ASS3
87-1286-004	1/-	24V	Verlängerungsstück für SML Kette Extension piece for SML chain	2 x 1,00 mm ²	[D]	2 pol. ASS2 2 pin ASS2
						2 pol. ASS2 2 pin ASS2
						2 x 2 pol. ASS2 2 x 2 pin ASS2



ADAPTERKABEL / ADAPTER CABLES

[E]



[F]

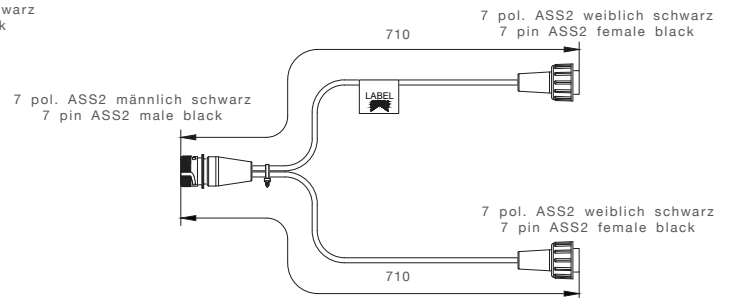
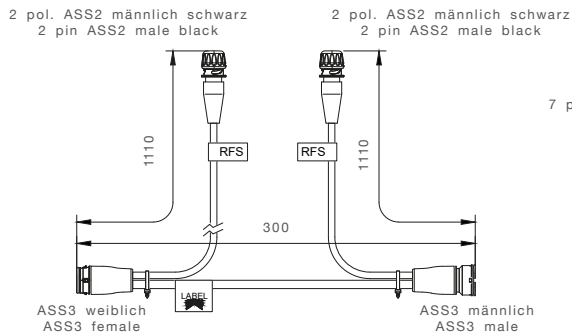
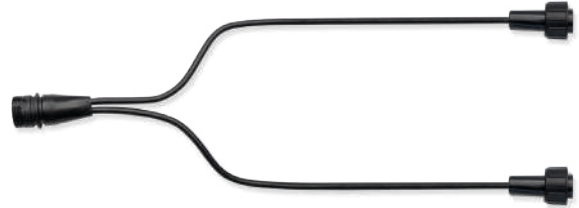

BEST. NR			BESCHREIBUNG	KABEL	ANSCHLUSS
PART NO			DESCRIPTION	CABLE	CONNECTOR
65-6101-024	1/-	24V	9 adriges Kabel 9 core cable	9 x 1,00 mm ²	[E] 17 pol. ASS3 17 pin ASS3
			2 x Abgang für RFS 2 x outlet for reverse lamp	2 x 1,00 mm ²	
68-4980-034	1/-	24V	Adapter Doppelbeleuchtung Adapter double lighting	7 x 1,00 mm ²	[F] 7 pol. ASS2 7 pin ASS2
					2 x 7 pol. ASS2 2 x 7 pin ASS2



VERLÄNGERUNGSKABEL / EXTENSION CABLES

[A]



[B]

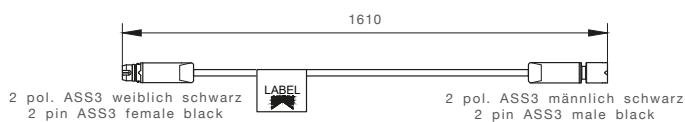

BEST. NR PART NO			KABEL CABLE	ANSCHLUSS CONNECTOR		
65-1499-004	1/-	24V	2 x 1,00 mm ²	[A]	2 pol. ASS3 2 pin ASS3   	
						2 pol. ASS3 2 pin ASS3   
65-1499-014	1/-	24V		[B]	2 pol. ASS3 2 pin ASS3   	
						2 pol. ASS3 2 pin ASS3   