

Falck® TEMS



ERSATZTEILE | SPARE PARTS

HECKLEUCHE

Tragen Ihre Fahrzeuge bereits „Aspöck“ am Heck?

Mit unseren unterschiedlichen Heckleuchten ermöglichen wir eine große Vielfalt – von einer klassischen Lichtlösung bis hin zu einem markentypischen Erscheinungsbild – in neuester LED-Technologie. Je nach Bedarf sind verschiedene Funktionen integriert, welche von Ein-, Zwei- bis Mehrfunktionsleuchten reichen. Sie bieten Ihnen als Aspöck-Komplettsystem zahlreiche Vorteile.

REAR LAMP

Do your vehicles already wear „Aspöck“ at the rear?

With our different rear lamps, we enable a wide variety – from a classic lighting solution to a brand-typical appearance – in the latest LED technology. Depending on requirements, various functions are integrated which extend from single-, dual- and multi-function lamps. They offer you numerous benefits in the Aspöck all-in-one system.

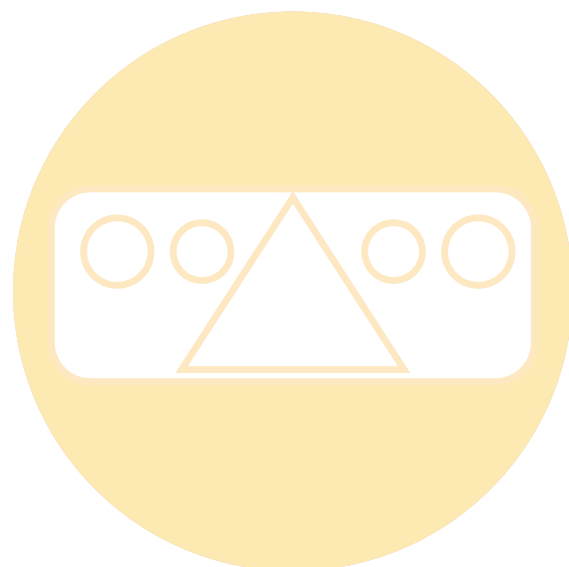



ECOLED III

ISO 13207-1 ADR Zone 2 IP 6K9K



Produktinformation
Product information

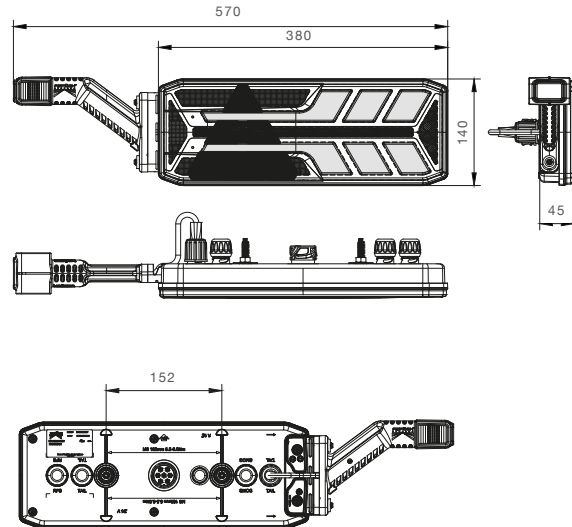
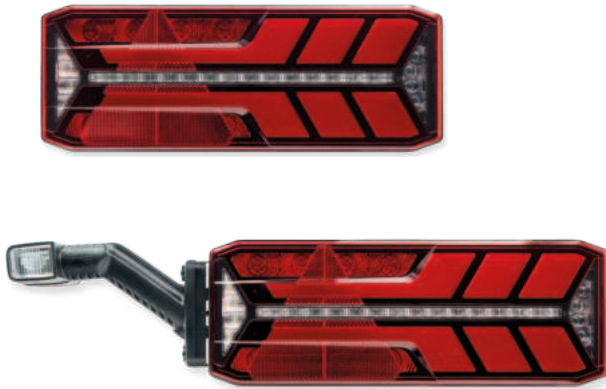

Dynamischer Blinker Progressive direction indicator	Rücklicht Tail light	Bremslicht Stop light	Nebelschlusslicht Fog light
Rückfahrlicht Reverse light	Dreieckrückstrahler Triangle reflector		

BEST. NR PART NO							ZUSATZ ADD ON	ANSCHLUSS CONNECTOR					
25-4122-011	1/-	●		LED	24V			7 pol. ASS2.1 7 pin ASS2.1					
25-4122-021	1/-	●		LED	24V			7 pol. ASS2.1 7 pin ASS2.1				4 x 2 pol. ASS2 4 x 2 pin ASS2	
25-4122-031	1/-	●		LED	24V	LED		7 pol. ASS2.1 7 pin ASS2.1				4 x 2 pol. ASS2 4 x 2 pin ASS2	
25-4122-041	1/-	●		LED	24V			7 pol. AMP 7 pin AMP					
25-4122-051	1/-	●		LED	24V			7 pol. AMP 7 pin AMP				4 x 2 pol. ASS2 4 x 2 pin ASS2	
25-4122-061	1/-	●		LED	24V	LED		7 pol. AMP 7 pin AMP				4 x 2 pol. ASS2 4 x 2 pin ASS2	
25-4123-011	1/-		●	LED	24V			7 pol. ASS2.1 7 pin ASS2.1					
25-4123-021	1/-		●	LED	24V			7 pol. ASS2.1 7 pin ASS2.1				4 x 2 pol. ASS2 4 x 2 pin ASS2	
25-4123-031	1/-		●	LED	24V	LED		7 pol. ASS2.1 7 pin ASS2.1				4 x 2 pol. ASS2 4 x 2 pin ASS2	
25-4123-041	1/-		●	LED	24V			7 pol. AMP 7 pin AMP					
25-4123-051	1/-		●	LED	24V			7 pol. AMP 7 pin AMP				4 x 2 pol. ASS2 4 x 2 pin ASS2	
25-4123-061	1/-		●	LED	24V	LED		7 pol. AMP 7 pin AMP				4 x 2 pol. ASS2 4 x 2 pin ASS2	



ECOLED III

ZUBEHÖR / ACCESSORIES

ISO
13207-1

ADR
Zone 2

IP 6K9K



- 1 ASS2 Verbinder | ASS2 connector**
 7 pol. weiblich
 7 pin. female 13-5626-631 
 7 pol. männlich
 7 pin. male 13-5625-981 

- 2 AMP Verbinder | AMP connector**
 7 pol. weiblich
 7 pin female 15-7002-024 
 7 pol. männlich
 7 pin male 15-7002-034 

- 3 Umrißarm LED inkl. Haltewinkel und Schrauben
 end outline marker LED incl. bracket and screws**
 (a) ASS2 links 12V / 24V
 ASS2 left 12V / 24V 31-3102-204 
 ASS2 rechts 12V / 24V
 ASS2 right 12V / 24V 31-3103-204 
 (b) Superseal links 12V / 24V
 Superseal left 12V / 24V .. 31-3102-214 
 Superseal rechts 12V / 24V
 Superseal right 12V / 24V 31-3103-214 

- 4 Halterung und Schrauben
 Bracket and screws**
 (a) 2 pol. weiblich
 2 pin female 15-5300-294 

THE ART OF LIGHTS

ECOLED III

SMCG inkludiert | *SMCG included*
Dynamischer Fahrtrichtungsanzeiger | *Progressive direction indicator*

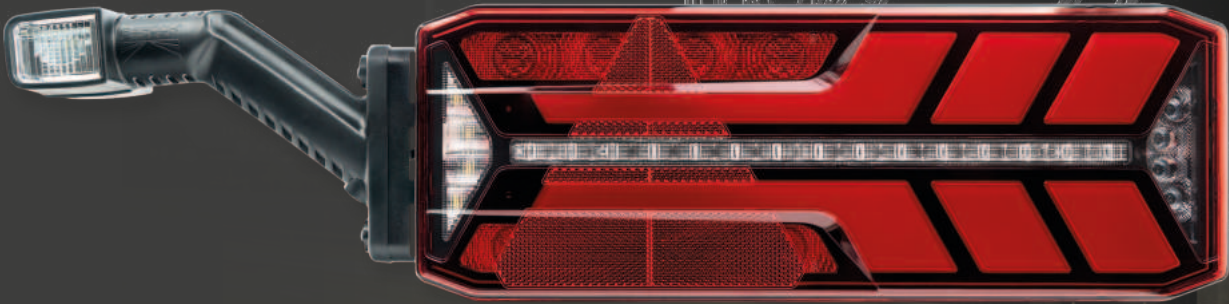

ECOLED II

Glowing Body Technologie | *Glowing body technology*
Beidseitig verwendbar | *Can be used on both sides*





ECOLED II



EcoLED II
Video
EcoLED II
video

Produktinformation
Product information

ISO
13207-1

ADR
Zone 2

IP 54

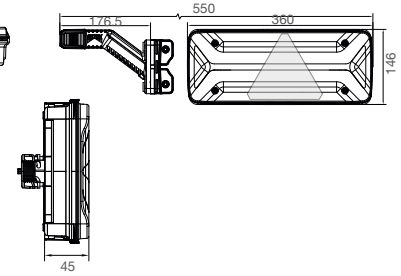
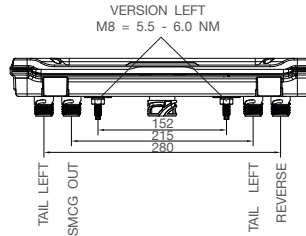
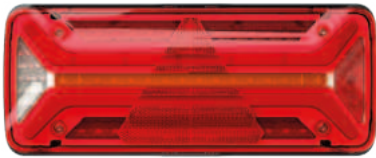

Dynamischer Blinker Progressive direction indicator	Rücklicht Tail light	Bremslicht Stop light	Nebelschlusslicht Fog light
Rückfahrlicht Reverse light	Dreieckrückstrahler Triangle reflector		

BEST. NR	Box	←	→	Light	V	LED	ZUSATZ	ANSCHLUSS
PART NO							ADD ON	CONNECTOR
25-4121-001	1/8	●		LED	12V 24V			7 pol. ASS2.1 7 pin ASS2.1
25-4121-011	1/8	●		LED	12V 24V			7 pol. ASS2.1 7 pin ASS2.1
25-4121-021	1/8	●		LED	12V 24V	LED		7 pol. ASS2.1 7 pin ASS2.1
25-4121-031	1/8	●		LED	12V 24V			7 pol. AMP 7 pin AMP
25-4121-041	1/8	●		LED	12V 24V			7 pol. AMP 7 pin AMP
25-4121-051	1/8	●		LED	12V 24V	LED		7 pol. AMP 7 pin AMP
25-4120-001	1/8		●	LED	12V 24V			7 pol. ASS2.1 7 pin ASS2.1
25-4120-011	1/8		●	LED	12V 24V			7 pol. ASS2.1 7 pin ASS2.1
25-4120-021	1/8		●	LED	12V 24V	LED		7 pol. ASS2.1 7 pin ASS2.1
25-4120-031	1/8		●	LED	12V 24V			7 pol. AMP 7 pin AMP
25-4120-041	1/8		●	LED	12V 24V			7 pol. AMP 7 pin AMP
25-4120-051	1/8		●	LED	12V 24V	LED		7 pol. AMP 7 pin AMP



ECOLED II Truck Version

ISO
13207-1

ADR
Zone 2

IP 54

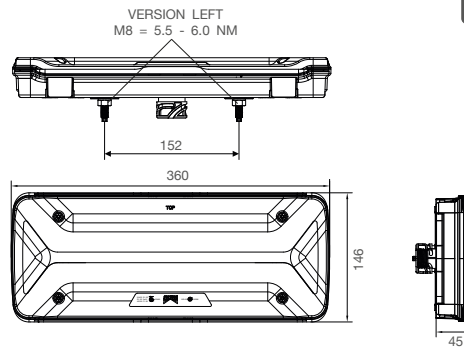
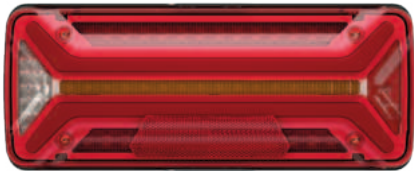

Blinklicht Direction indicator	Rücklicht Tail light	Bremslicht Stop light	Nebelschlusslicht Fog light
Rückfahrlicht Reverse light			

BEST. NR							ZUSATZ ADD ON	ANSCHLUSS CONNECTOR
25-4121-061	1/8	●		LED	12V 24V			7 pol. AMP 7 pin AMP ♂
25-4120-061	1/8		●	LED	12V 24V			7 pol. AMP 7 pin AMP ♂



ECOLED II

ZUBEHÖR / ACCESSORIES



- 1 Lichtscheibe | lens**
mit Dreieck 18-8536-001 
ohne Dreieck 18-8536-011 

- 2 Umrissarm LED inkl. Haltewinkel und Schrauben
end outline marker LED incl. bracket and screws**
- (a) ASS2 links 12V / 24V
ASS2 left 12V / 24V 31-3103-204 
ASS2 rechts 12V / 24V 31-3102-204 
- (b) Superseal links 12V / 24V
Superseal left 12V / 24V .. 31-3103-214 
Superseal rechts 12V / 24V 31-3102-214 

- 3 Haltewinkel + Schrauben | bracket + screws**
..... 15-5300-294 

- 4 ASS1 & ASS2 Verbinder |
ASS1 & ASS2 connector**
- (a) 2 pol. weiblich
2 pin female 13-5626-401 
- (b) 7 pol. weiblich
7 pin female 13-5626-631 
- (c) Verschlusskappe
closed connection 15-5623-304 

- 5 Superseal Verbinder |
Superseal connector**
2 pol. weiblich
2 pin female 15-7002-044 

- 6 AMP Verbinder |
AMP connector**
7 pol. weiblich
7 pin female 15-7002-024 

- 7 Schutzhaube | protection cap**
..... 25-7537-154 



ECOLED

ADR Zone 2 IP69K



Produktinformation
Product information

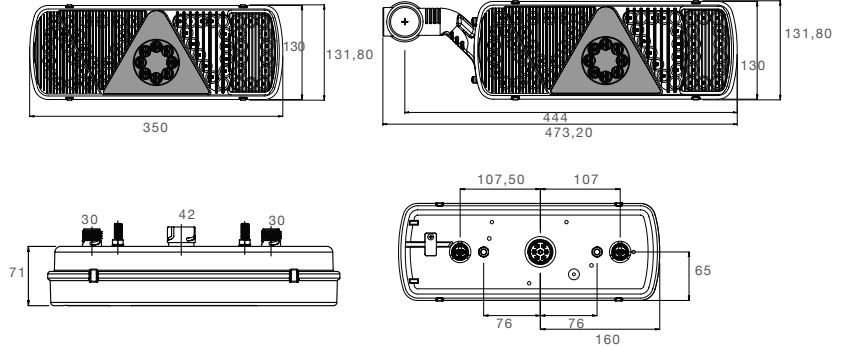

Blinklicht Direction indicator	Rücklicht Tail light	Bremslicht Stop light	Nebelschlusslicht Fog light
Rückfahrlicht Reverse light	Dreieckrückstrahler Triangle reflector	Seitenmarkierungslicht + Reflektor Sidemarker light + reflector	

BEST. NR	PART NO	←	→	LED	24V	LED	ZUSATZ ADD ON	ANSCHLUSS CONNECTOR
25-3800-501	1/10	●		LED	24V			7 pol. ASS2 7 pin ASS2
25-3800-511	1/6	●		LED	24V			7 pol. ASS2.1 7 pin ASS2.1
25-3820-511	1/8	●		LED	24V	LED		7 pol. ASS2.1 7 pin ASS2.1
25-3900-501	1/10		●	LED	24V			7 pol. ASS2 7 pin ASS2
25-3900-511	1/6		●	LED	24V			7 pol. ASS2.1 7 pin ASS2.1
25-3920-511	1/8		●	LED	24V	LED		7 pol. ASS2.1 7 pin ASS2.1



ECOLED

ZUBEHÖR / ACCESSORIES



1 Umrissarm LED | outline marker LED

- rot / weiß / orange links
red / white / orange left
..... 31-3305-234 
- rot / weiß / orange rechts
red / white / orange right
..... 31-3306-234 

2 Schutzhaube | protection cap

- 15-5277-004 

3 ASS1 & ASS2 Verbinder |
ASS1 & ASS2 connector

- (a) 2 pol. weiblich
2 pin female 13-5626-401 
- (b) 7 pol. weiblich
7 pin female 13-5626-631 
- (c) Verschlusskappe
closed connection 15-5623-304 

4 LED Vorschaltgerät | LED control gear

- 75-0309-001 
- siehe Seite 166
see at page 166



EUROPOINT III links left

ADR Zone 2 IP 56K



Produktinformation
Product information



Europoint III
Video
Europoint III
video

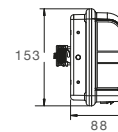
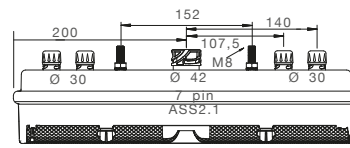
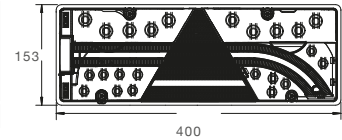
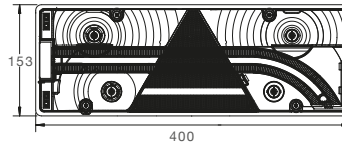

Blinklicht Direction indicator	Rücklicht Tail light	Bremslicht Stop light	Nebelschlusslicht Fog light
Rückfahrlicht Reverse light	Dreieckrückstrahler Triangle reflector	Seitenmarkierungslicht + Reflektor Sidemarker light + reflector	

BEST. NR PART NO		←	→				ZUSATZ ADD ON	ANSCHLUSS CONNECTOR
25-7000-501	1/10	●			24V			7 pol. ASS2.1 7 pin ASS2.1 ♂
25-7000-511	1/10	●			24V			7 pol. ASS2.1 7 pin ASS2.1 ♂ 4 x 2 pol. ASS2 4 x 2 pin ASS2
25-7000-701	1/10	●			24V			7 pol. ASS2.1 7 pin ASS2.1 ♂
25-7000-711	1/10	●			24V			7 pol. ASS2.1 7 pin ASS2.1 ♂ 4 x 2 pol. ASS2 4 x 2 pin ASS2
25-7000-721	1/10	●			24V			7 pol. ASS2.1 7 pin ASS2.1 ♂
25-7000-741	1/10	●			24V			7 pol. ASS2.1 7 pin ASS2.1 ♂
25-7030-721	1/10	●			24V			7 pol. AMP 7 pin AMP ♂ 4 x 2 pol. Superseal 4 x 2 pin Superseal
25-7001-501	1/6	●			24V			7 pol. ASS2.1 7 pin ASS2.1 ♂
25-7001-601	1/10	●			24V			7 pol. ASS2.1 7 pin ASS2.1 ♂ 4 x 2 pol. ASS2 4 x 2 pin ASS2
25-7030-711	1/10	●			24V			7 pol. AMP 7 pin AMP ♂ 4 x 2 pol. Superseal 4 x 2 pin Superseal
25-7001-611	1/10	●			24V			7 pol. ASS2.1 7 pin ASS2.1 ♂ 4 x 2 pol. ASS2 4 x 2 pin ASS2
25-7002-001	1/10	●			24V			7 pol. ASS2.1 7 pin ASS2.1 ♂ 4 x 2 pol. ASS2 4 x 2 pin ASS2
25-7000-761	1/10	●			24V			7 pol. ASS2.1 7 pin ASS2.1 ♂ 4 x 2 pol. ASS2 4 x 2 pin ASS2



EUROPOINT III rechts
right

ADR Zone 2 IP 56K

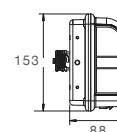
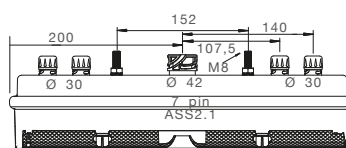
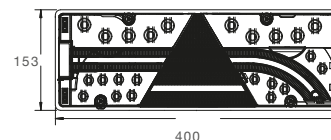
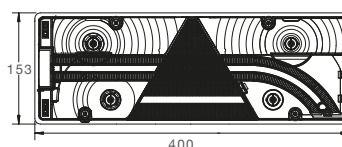

Blinklicht Direction indicator	Rücklicht Tail light	Bremslicht Stop light	Nebelschlusslicht Fog light
Rückfahrlicht Reverse light	Dreieckrückstrahler Triangle reflector	Seitenmarkierungslicht + Reflektor Sidemarker light + reflector	

BEST. NR PART NO							ZUSATZ ADD ON	ANSCHLUSS CONNECTOR
25-7430-721	1/10		●	LED	24V			7 pol. AMP 7 pin AMP ♂ 4 x 2 pol. Superseal 4 x 2 pin Superseal
25-7400-501	1/10		●	LED	24V			7 pol. ASS2.1 7 pin ASS2.1 ♂
25-7400-511	1/10		●	LED	24V			7 pol. ASS2.1 7 pin ASS2.1 ♂ 4 x 2 pol. ASS2 4 x 2 pin ASS2
25-7400-701	1/10		●	LED	24V			7 pol. ASS2.1 7 pin ASS2.1 ♂
25-7400-711	1/10		●	LED	24V			7 pol. ASS2.1 7 pin ASS2.1 ♂ 4 x 2 pol. ASS2 4 x 2 pin ASS2
25-7400-721	1/10		●	LED	24V			7 pol. ASS2.1 7 pin ASS2.1 ♂
25-7400-741	1/10		●	LED	24V			7 pol. ASS2.1 7 pin ASS2.1 ♂
25-7401-531	1/10		●	LED	24V			7 pol. ASS2.1 7 pin ASS2.1 ♂
25-7401-601	1/6		●	LED	24V			7 pol. ASS2.1 7 pin ASS2.1 ♂ 4 x 2 pol. ASS2 4 x 2 pin ASS2
25-7430-711	1/10		●	LED	24V			7 pol. AMP 7 pin AMP ♂ 4 x 2 pol. Superseal 4 x 2 pin Superseal
25-7401-611	1/10		●	LED	24V			7 pol. ASS2.1 7 pin ASS2.1 ♂ 4 x 2 pol. ASS2 4 x 2 pin ASS2
25-7402-001	1/10		●	LED	24V			7 pol. ASS2.1 7 pin ASS2.1 ♂ 4 x 2 pol. ASS2 4 x 2 pin ASS2
25-7400-761	1/10		●	LED	24V			7 pol. ASS2.1 7 pin ASS2.1 ♂ 4 x 2 pol. ASS2 4 x 2 pin ASS2



EUROPOINT III links mit Umrissarm
left with end outline marker

ADR Zone 2 IP56K

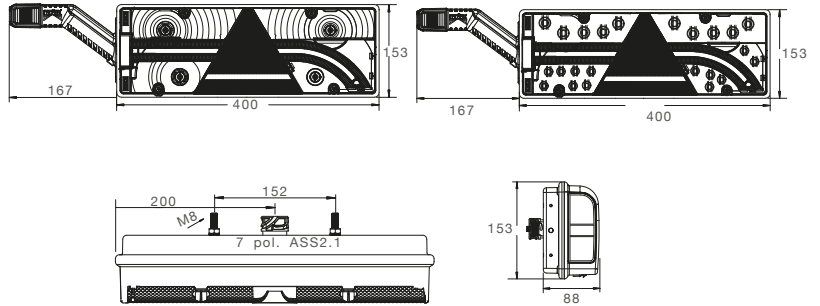

Blinklicht Direction indicator	Rücklicht Tail light	Bremslicht Stop light	Nebelschlusslicht Fog light
Rückfahrt Reverse light	Dreieckrückstrahler Triangle reflector	Seitenmarkierungslicht + Reflektor Sidemarker light + reflector	

BEST. NR		←	→	💡	⚡	☀️	ZUSATZ	ANSCHLUSS
PART NO							ADD ON	CONNECTOR
25-7020-501	1/6	●		LED	24V	LED		7 pol. ASS2.1 7 pin ASS2.1 ♂
25-7020-511	1/6	●		LED	24V	LED		7 pol. ASS2.1 7 pin ASS2.1 ♂ 4 x 2 pol. ASS2 4 x 2 pin ASS2
25-7020-541	1/6	●		LED	24V	LED		7 pol. ASS2.1 7 pin ASS2.1 ♂
25-7020-701	1/6	●		LED	24V	LED		7 pol. ASS2.1 7 pin ASS2.1 ♂
25-7020-711	1/6	●		LED	24V	LED		7 pol. ASS2.1 7 pin ASS2.1 ♂ 4 x 2 pol. ASS2 4 x 2 pin ASS2
25-7020-721	1/6	●		LED	24V	LED		7 pol. ASS2.1 7 pin ASS2.1 ♂
25-7020-731	1/8	●		LED	24V	LED		7 pol. ASS2.1 7 pin ASS2.1 ♂
25-7021-511	1/6	●		LED	24V	LED		7 pol. ASS2.1 7 pin ASS2.1 ♂ 4 x 2 pol. ASS2 4 x 2 pin ASS2
25-7002-101	1/6	●		LED	24V	LED		7 pol. ASS2.1 7 pin ASS2.1 ♂ 4 x 2 pol. ASS2 4 x 2 pin ASS2
25-7020-741	1/6	●		LED	24V	LED		7 pol. ASS2.1 7 pin ASS2.1 ♂ 4 x 2 pol. ASS2 4 x 2 pin ASS2
25-7020-751	1/6	●		LED	24V	LED		7 pol. ASS2.1 7 pin ASS2.1 ♂ 4 x 2 pol. ASS2 4 x 2 pin ASS2
25-7021-521	1/6	●		LED	24V	LED		7 pol. ASS2.1 7 pin ASS2.1 ♂ 4 x 2 pol. ASS2 4 x 2 pin ASS2



EUROPOINT III rechts mit Umrissarm
right with end outline marker

ADR Zone 2 IP 56K

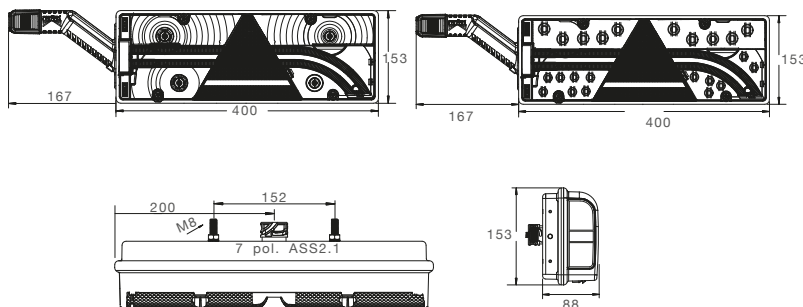

Blinklicht Direction indicator	Rücklicht Tail light	Bremslicht Stop light	Nebelschlusslicht Fog light
Rückfahrlicht Reverse light	Dreieckrückstrahler Triangle reflector	Seitenmarkierungslicht + Reflektor Sidemarker light + reflector	

BEST. NR PART NO		←	→				ZUSATZ ADD ON	ANSCHLUSS CONNECTOR
25-7420-501	1/6		●	LED	24V	LED		7 pol. ASS2.1 7 pin ASS2.1
25-7420-511	1/6		●	LED	24V	LED		7 pol. ASS2.1 7 pin ASS2.1
25-7420-541	1/6		●	LED	24V	LED		7 pol. ASS2.1 7 pin ASS2.1
25-7420-551	1/6		●	LED	24V	LED		7 pol. ASS2.1 7 pin ASS2.1
25-7420-701	1/6		●	LED	24V	LED		7 pol. ASS2.1 7 pin ASS2.1
25-7420-711	1/6		●	LED	24V	LED		7 pol. ASS2.1 7 pin ASS2.1
25-7420-721	1/6		●	LED	24V	LED		7 pol. ASS2.1 7 pin ASS2.1
25-7420-751	1/6		●	LED	24V	LED		7 pol. ASS2.1 7 pin ASS2.1
25-7420-761	1/6		●	LED	24V	LED		7 pol. ASS2.1 7 pin ASS2.1
25-7421-521	1/6		●	LED	24V	LED		7 pol. ASS2.1 7 pin ASS2.1
25-7402-101	1/6		●	LED	24V	LED		7 pol. ASS2.1 7 pin ASS2.1
25-7420-741	1/6		●	LED	24V	LED		7 pol. ASS2.1 7 pin ASS2.1
25-7420-771	1/6		●	LED	24V	LED		7 pol. ASS2.1 7 pin ASS2.1
25-7421-531	1/6		●	LED	24V	LED		7 pol. ASS2.1 7 pin ASS2.1



EUROPOINT III Truck Version

ADR Zone 2 IP 56K



Produktinformation
Product information

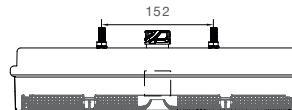
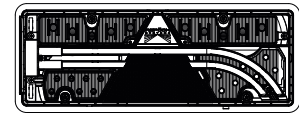
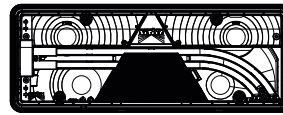

Blinklicht Direction indicator	Rücklicht Tail light	Bremslicht Stop light	Nebelschlusslicht Fog light
Rückfahrlicht Reverse light	Seitenmarkierungslicht + Reflektor Sidemarker light + reflector		

BEST. NR							ZUSATZ	ANSCHLUSS
PART NO							ADD ON	CONNECTOR
25-7000-541	1/10	●			24V			7 pol AMP 7 pin AMP ♂
25-7000-751	1/10	●			24V			7 pol AMP 7 pin AMP ♂
25-7400-541	1/10		●		24V			7 pol AMP 7 pin AMP ♂
25-7400-751	1/10		●		24V			7 pol AMP 7 pin AMP ♂



EUROPOINT III

ZUBEHÖR / ACCESSORIES

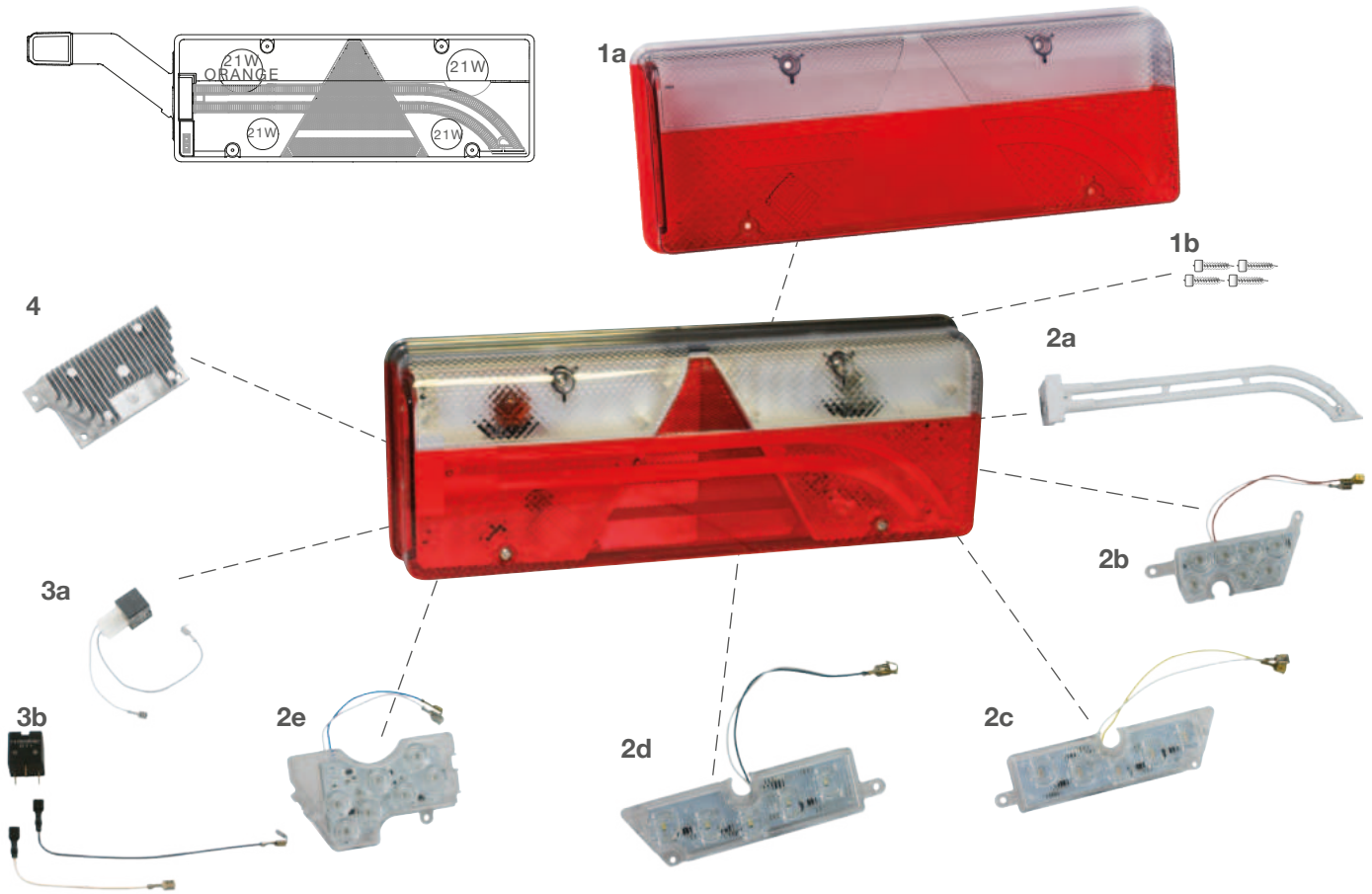

1 (a) Lichtscheibe | lens

- links
- left..... 18-8570-001
- rechts
- right 18-8570-101
- links mit KZL
- left with no. plate lamp 18-8570-011
- rechts mit KZL
- right with no. plate lamp 18-8570-111

(b) Schrauben für Lichtscheibe | Screws for lens

- 14-1430-554

2 LED Einsätze | LED inserts

- (a) Rücklicht links („Light Guide“) 12V / 24V
- tail left („Light Guide“) 12V / 24V
- 12-1570-001
- Rücklicht rechts („Light Guide“) 12V / 24V
- tail right („Light Guide“) 12V / 24V
- 12-1570-101
- (b) Bremslicht links 12V / 24V
- stop left 12V / 24V
- 12-1570-204

- Bremslicht rechts 12V / 24V
- stop light right 12V / 24V
- 12-1574-204

- (c) Blinklicht links 24V
- direction indicator left 24V
- 12-1570-224
- Blinklicht rechts 24V
- direction indicator right 24V
- 12-1574-224

- (d) Rückfahrlicht links 24V
- reverse left 24V 12-1570-234
- Rückfahrlicht rechts 24V
- reverse right 24V 12-1574-234

- (e) Nebelschlusslicht links 24V
- fog left 24V 12-1570-214
- Nebelschlusslicht rechts 24V
- fog right 24V 12-1574-214

3 Relais

- (a) Rückfahrwarner 24V
- reverse alarm 24V
- 12-3922-004
- (b) SMCG Steuerung für Seitenmarkierungsleuchten
- SMCG side marker control gear
- 12-3970-584



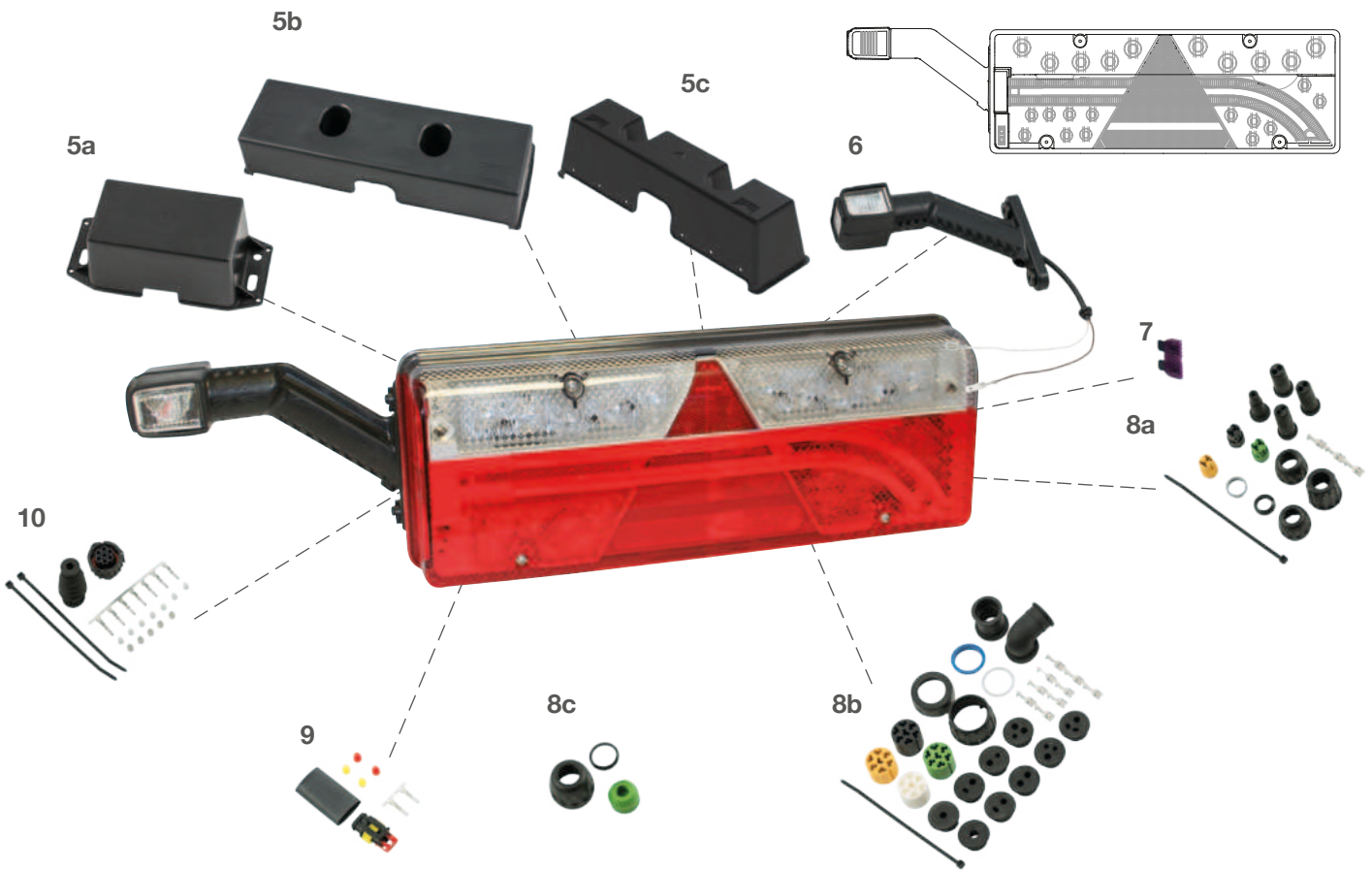

EUROPOINT III

ZUBEHÖR / ACCESSORIES



4 LED Vorschaltgerät | LED control gear
 LCG 25-7008-024 
 siehe Seite 188
 see at page 188

5 Schutzhaube | protection cap
 (a) klein
 small 15-5270-004 
 (b) groß
 big 15-5276-001 
 (c) groß
 big 25-7537-154 

6 Umrissarm LED | outline marker LED
 links 12V / 24V
 left 12V / 24V 31-3103-024 
 rechts 12V / 24V
 right 12V / 24V 31-3102-024 

7 Sicherung | fuse
 3 A 12-6830-094 

8 ASS1 & ASS2 Verbinder |
 ASS1 & ASS2 connector
 (a) 2 pol. weiblich
 2 pin female 13-5626-401 
 (b) 7 pol. weiblich
 7 pin female 13-5626-631 
 (c) Verschlusskappe
 closed connection 15-5623-304 

9 Superseal Verbinder |
 Superseal connector
 2 pol. weiblich
 2 pin female 15-7002-044 

10 AMP Verbinder |
 AMP connector
 7 pol. weiblich
 7 pin female 15-7002-024 



EUROPOINT II links
left

ADR
Zone 2

IP 54

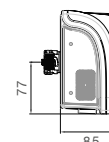
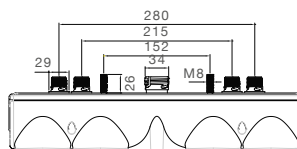
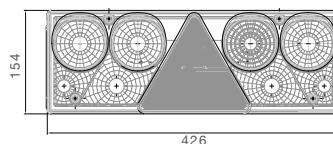

Blinklicht Direction indicator	Rücklicht Tail light	Bremslicht Stop light	Nebelschlusslicht Fog light
Rückfahrlicht Reverse light	Dreieckrückstrahler Triangle reflector	Seitenmarkierungslicht + Reflektor Sidemarker light + reflector	

BEST. NR	PART NO		←	→				ZUSATZ	ANSCHLUSS	
								ADD ON	CONNECTOR	
25-6000-501	1/10	●				24V			7 pol. ASS2 7 pin ASS2	
25-6000-701	1/10	●				24V			7 pol. ASS2 7 pin ASS2	
25-6000-711	1/10	●				24V			7 pol. ASS2.1 7 pin ASS 2.1	
25-6000-721	1/10	●				24V			7 pol. ASS2 7 pin ASS2	
25-6000-741	1/10	●				24V			7 pol. ASS2 7 pin ASS2	
25-6000-751	1/10	●				24V			7 pol. ASS2 7 pin ASS2	
25-6001-501	1/10	●				24V			7 pol. ASS2 7 pin ASS2	
25-6010-501	1/10	●				24V			7 pol. ASS2.1 7 pin ASS2.1	4 x 2 pol. ASS2 4 x 2 pin ASS2
25-6010-541	1/10	●				24V			7 pol. ASS2 7 pin ASS2	
25-6011-501	1/10	●				24V			7 pol. ASS2.1 7 pin ASS 2.1	4 x 2 pol. ASS2 4 x 2 pin ASS2
25-6030-501	1/10	●				24V			7 pol. AMP 7 pin AMP	4 x 2 pol. Superseal 4 x 2 pin Superseal
25-6030-701	1/10	●				24V			7 pol. AMP 7 pin AMP	4 x 2 pol. Superseal 4 x 2 pin Superseal
25-6030-711	1/10	●				24V			7 pol. AMP 7 pin AMP	4 x 2 pol. Superseal 4 x 2 pin Superseal
25-6101-501	1/10	●				24V			7 pol. ASS2 7 pin ASS2	2 x 2 pol. ASS2 2 x 2 pin ASS2
25-6200-501	1/10	●				24V			7 pol. ASS2 7 pin ASS2	4 x 2 pol. ASS2 4 x 2 pin ASS2
25-6030-721	1/10	●				24V			7 pol. AMP 7 pin AMP	4 x 2 pol. Superseal 4 x 2 pin Superseal



EUROPOINT II rechts right

ADR Zone 2

IP 54

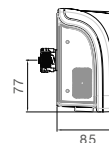
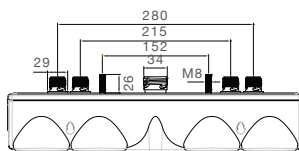
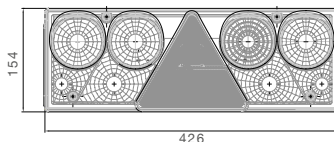

Blinklicht Direction indicator	Rücklicht Tail light	Bremslicht Stop light	Nebelschlusslicht Fog light
Rückfahrlicht Reverse light	Dreieckrückstrahler Triangle reflector	Seitenmarkierungslicht + Reflektor Sidemarker light + reflector	

BEST. NR	PART NO		←	→				ZUSATZ	ANSCHLUSS	
								ADD ON	CONNECTOR	
25-6400-501	1/11		●		24V				7 pol. ASS2 7 pin ASS2	
25-6400-701	1/11		●		24V				7 pol. ASS2 7 pin ASS2	
25-6400-711	1/10		●		24V				7 pol. ASS2.1 7 pin ASS 2.1	
25-6400-721	1/10		●		24V				7 pol. ASS2 7 pin ASS2	
25-6400-741	1/10		●		24V				7 pol. ASS2 7 pin ASS2	
25-6400-751	1/10		●		24V				7 pol. ASS2 7 pin ASS2	
25-6401-501	1/10		●		24V				7 pol. ASS2 7 pin ASS2	
25-6410-501	1/10		●		24V				7 pol. ASS2.1 7 pin ASS2.1	4 x 2 pol. ASS2 4 x 2 pin ASS2
25-6411-501	1/10		●		24V				7 pol. ASS2.1 7 pin ASS 2.1	4 x 2 pol. ASS2 4 x 2 pin ASS2
25-6430-701	1/10		●		24V				7 pol. AMP 7 pin AMP	4 x 2 pol. Superseal 4 x 2 pin Superseal
25-6430-711	1/10		●		24V				7 pol. AMP 7 pin AMP	4 x 2 pol. Superseal 4 x 2 pin Superseal
25-6501-501	1/10		●		24V				7 pol. ASS2 7 pin ASS2	2 x 2 pol. ASS2 2 x 2 pin ASS2
25-6501-511	1/10		●		24V				7 pol. ASS2 7 pin ASS2	2 x 2 pol. ASS2 2 x 2 pin ASS2
25-6600-501	1/10		●		24V				7 pol. ASS2 7 pin ASS2	4 x 2 pol. ASS2 4 x 2 pin ASS2
25-6601-511	1/10		●		24V				7 pol. ASS2 7 pin ASS2	4 x 2 pol. ASS2 4 x 2 pin ASS2
25-6430-721	1/10		●		24V				7 pol. AMP 7 pin AMP	4 x 2 pol. Superseal 4 x 2 pin Superseal

EUROPOINT II links mit Umrissarm
left with end outline marker

ADR
Zone 2

IP 54

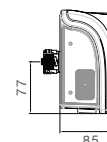
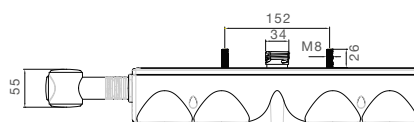
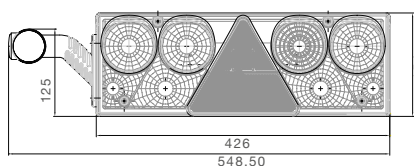

Blinklicht Direction indicator	Rücklicht Tail light	Bremslicht Stop light	Nebelschlusslicht Fog light
Rückfahrlicht Reverse light	Dreieckrückstrahler Triangle reflector	Seitenmarkierungslicht + Reflektor Sidemarker light + reflector	

BEST. NR							ZUSATZ	ANSCHLUSS	
PART NO							ADD ON	CONNECTOR	
25-6011-511	1/6	●			24V			7 pol. ASS2 7 pin ASS2	
25-6011-701	1/6	●			24V			7 pol. ASS2 7 pin ASS2	
25-6015-501	1/6	●			24V			7 pol. ASS2 7 pin ASS2	
25-6020-751	1/6	●			24V			7 pol. ASS2 7 pin ASS2	
25-6021-701	1/6	●			24V			7 pol. ASS2 7 pin ASS2	
25-6110-501	1/6	●			24V			7 pol. ASS2 7 pin ASS2	
25-6110-711	1/6	●			24V			7 pol. ASS2 7 pin ASS2	
25-6210-501	1/6	●			24V			7 pol. ASS2 7 pin ASS2	
25-6211-501	1/6	●			24V			7 pol. ASS2 7 pin ASS2	



EUROPOINT II rechts mit Umrissarm
right with end outline marker

ADR Zone 2

IP 54

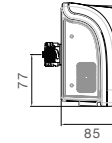
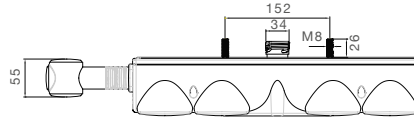
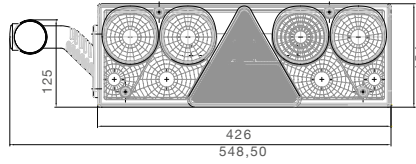

Blinklicht Direction indicator	Rücklicht Tail light	Bremslicht Stop light	Nebelschlusslicht Fog light
Rückfahrlicht Reverse light	Dreieckrückstrahler Triangle reflector	Seitenmarkierungslicht + Reflektor Sidemarker light + reflector	

BEST. NR							ZUSATZ	ANSCHLUSS	
PART NO							ADD ON	CONNECTOR	
25-6411-511	1/6		●		24V			7 pol. ASS2 7 pin ASS2	
25-6415-501	1/6		●		24V			7 pol. ASS2 7 pin ASS2	
25-6420-751	1/6		●	LED	24V	LED		7 pol. ASS2 7 pin ASS2	
25-6421-701	1/6		●		24V	LED		7 pol. ASS2 7 pin ASS2	
25-6510-501	1/6		●		24V			7 pol. ASS2 7 pin ASS2	
25-6510-711	1/6		●		24V	LED		7 pol. ASS2 7 pin ASS2	
25-6610-501	1/6		●		24V			7 pol. ASS2 7 pin ASS2	



EUROPOINT II

ZUBEHÖR / ACCESSORIES

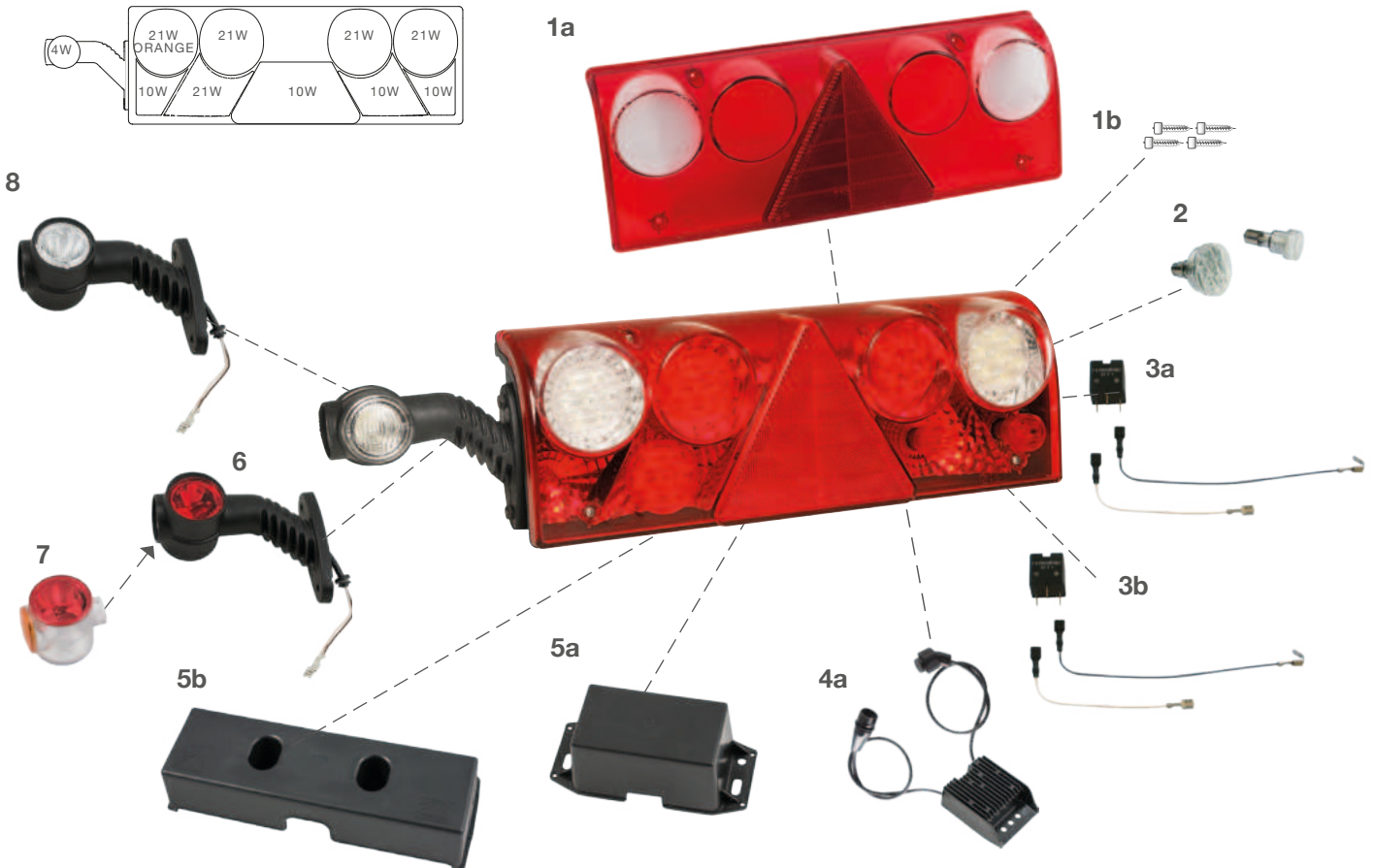

1 (a) Lichtscheibe | lens
..... 18-8560-002 



**(b) Schrauben für Lichtscheibe |
Screws for lens**
..... 14-1430-454 



2 LED Einsätze | LED inserts
Rücklicht 12V / 24V
tail light 12V / 24V..... 12-1560-001 
Bremslicht 12V / 24V
stop light 12V / 24V 12-1560-141 
Blinklicht 24V
direction indicator 24V... 12-1560-011 
Rückfahrlicht 24V
reversing light 24V 12-1560-021 
Nebelschlusslicht 24V
fog light 24V..... 12-1560-031 

3 Relais
(a) Rückfahrwarner 24V
reverse alarm 24V
..... 12-3922-004 

(b) SMCG Steuerung für Seitenmarkierungsleuchten
SMCG side marker control gear
..... 12-3970-584

4 LED Vorschaltgerät | LED control gear
(a) LCG 1 - V2 75-0300-101
siehe Seite 188
see at page 188

5 Schutzhaube | protection cap
(a) klein
small 15-5270-004 
(b) groß
big 15-5276-001 

6 Umrissarm Glühlampe | outline marker bulb
rot / weiß / orange links
red / white / orange left
..... 31-3305-064 
rot / weiß / orange rechts
red / white / orange right
..... 31-3306-064 



7 Lichtscheibe Umrissarm | lens outline marker
..... 18-8141-004 



EUROPOINT II

ZUBEHÖR / ACCESSORIES



- 8 Umrissarm LED | outline marker LED**
 rot / weiß links
 red / white left 31-3305-084 
 rot / weiß rechts
 red / white right 31-3306-084 

- 9 Sicherung | fuse**
 3 A 12-6830-094 

- 10 ASS1 & ASS2 Verbinder |
 ASS1 & ASS2 connector**
 (a) 2 pol. weiblich
 2 pin female 13-5626-401 
 (b) 7 pol. weiblich
 7 pin female 13-5626-631 
 (c) Verschlusskappe
 closed connection 15-5623-304 

- 11 Superseal Verbinder |
 Superseal connector**
 2 pol. weiblich
 2 pin female 15-7002-044 

- 12 AMP Verbinder |
 AMP connector**
 7 pol. weiblich
 7 pin female 15-7002-024 



EUROPOINT I

ADR
Zone 2

IP 54

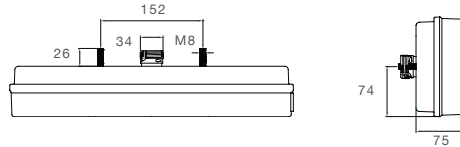
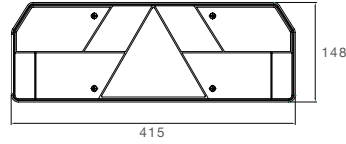

Blinklicht Direction indicator	Rücklicht Tail light	Bremslicht Stop light	Nebelschlusslicht Fog light
Rückfahrlicht Reverse light	Dreieckrückstrahler Triangle reflector	Seitenmarkierungslicht + Reflektor Sidemarker light + reflector	Begrenzungslicht hinten Rear position light

BEST. NR							ZUSATZ	ANSCHLUSS
PART NO							ADD ON	CONNECTOR
25-5000-501	1/10	●			24V			7 pol. ASS2 7 pin ASS2
25-5001-501	1/10	●			24V			7 pol. ASS2 7 pin ASS2
25-5100-501	1/13	●			24V			PG Verschraubung cable glands
25-5400-501	1/10		●		24V			7 pol. ASS2 7 pin ASS2
25-5401-501	1/10		●		24V			7 pol. ASS2 7 pin ASS2
25-5500-501	1/13		●		24V			PG Verschraubung cable glands



EUROPOINT I

ZUBEHÖR / ACCESSORIES

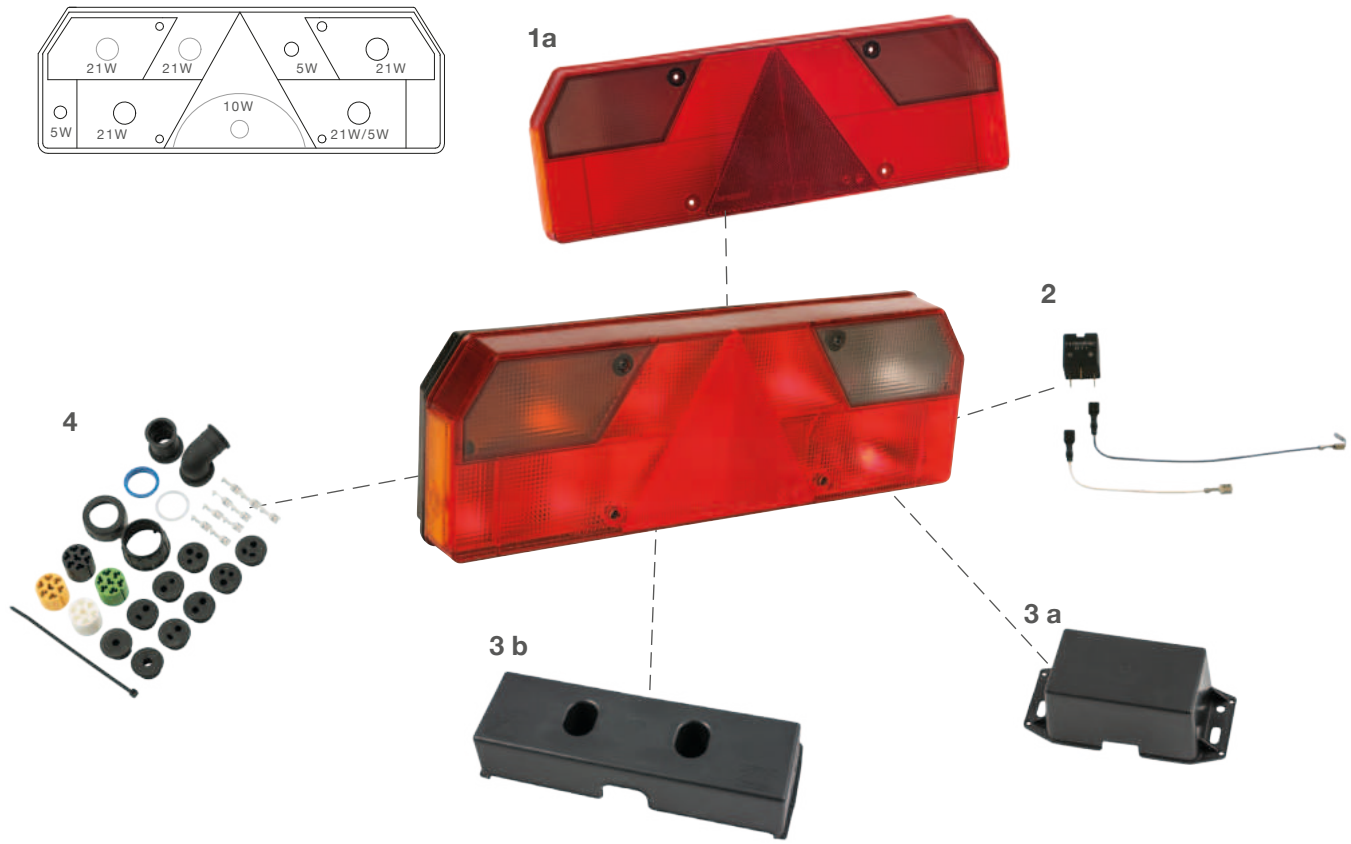

- 1 Lichtscheibe | lens**
 (a) Ohne Kennzeichenleuchte
 without number plate lamp
 18-8550-002

- 2 Rückfahrwarner 24V | reverse alarm 24V**
 12-3922-004

- 3 Schutzhaube | protection cap**
 (a) klein
 small 15-5270-004
 (b) groß
 big 15-5276-001

- 4 ASS1 & ASS2 Verbinder |
 ASS1 & ASS2 connector**
 7 pol. weiblich
 7 pin female 13-5626-631

Glühlampe | bulb
 24V 5W 16-6305-027



ECOPOINT II

links
left

ADR Zone 2 IP 56K



Produktinformation
Product information

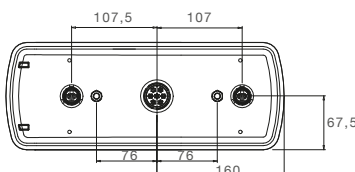
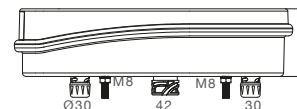
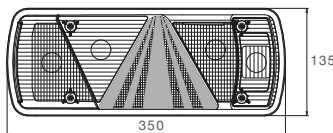

Blinklicht Direction indicator	Rücklicht Tail light	Bremslicht Stop light	Nebelschlusslicht Fog light
Rückfahrlicht Reverse light	Dreieckrückstrahler Triangle reflector	Seitenmarkierungslicht + Reflektor Sidemarker light + reflector	

BEST. NR PART NO						ZUSATZ ADD ON	ANSCHLUSS CONNECTOR
25-2800-001	1/6	●			24V		7 pol. ASS2.1 7 pin ASS2.1 ♂
25-2800-451	1/6	●			24V		7 pol. ASS2 7 pin ASS2 ♂
25-2800-501	1/6	●			24V		7 pol. ASS2 7 pin ASS2 ♂
25-2800-511	1/6	●			24V		7 pol. ASS2 7 pin ASS2 ♂ 2 x 2 pol. ASS2 2 x 2 pin ASS2
25-2800-521	1/10	●			24V		7 pol. ASS2 7 pin ASS2 ♂ 2 x 2 pol. ASS2 2 x 2 pin ASS2
25-2801-501	1/6	●			24V		7 pol. ASS2 7 pin ASS2 ♂
25-2860-001	1/6	●			24V		7 pol. ASS2.1 7 pin ASS2.1 ♂
25-2801-701	1/6	●			24V		7 pol. ASS2.1 7 pin ASS2.1 ♂
25-2860-701	1/8	●			24V		7 pol. ASS2.1 7 pin ASS2.1 ♂
25-2880-521	1/6	●			24V		7 pol. AMP 7 pin AMP ♂ 2 x 2 pol. Superseal 2 x 2 pin Superseal
25-2860-041	1/8	●			24V		7 pol. ASS2.1 7 pin ASS2.1 ♂
25-2860-701	1/8	●			24V		7 pol. ASS2.1 7 pin ASS2.1 ♂



ECOPOINT II

rechts
right

ADR Zone 2 IP 56K



Produktinformation
Product information

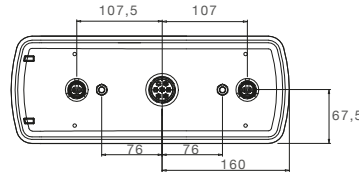
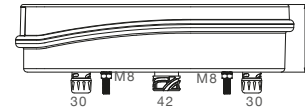
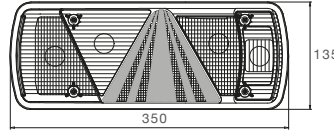

Blinklicht Direction indicator	Rücklicht Tail light	Bremslicht Stop light	Nebelschlusslicht Fog light
Rückfahrlicht Reverse light	Dreieckrückstrahler Triangle reflector	Seitenmarkierungslicht + Reflektor Sidemarker light + reflector	

BEST. NR PART NO						ZUSATZ ADD ON	ANSCHLUSS CONNECTOR
25-2900-001	1/6		●		24V		7 pol. ASS2.1 7 pin ASS2.1 ♂
25-2900-451	1/6		●		24V		7 pol. ASS2 7 pin ASS2 ♂
25-2900-501	1/6		●		24V		7 pol. ASS2 7 pin ASS2 ♂
25-2900-511	1/6		●		24V		7 pol. ASS2 7 pin ASS2 ♂ 2 x 2 pol. ASS2 2 x 2 pin ASS2
25-2900-521	1/6		●		24V		7 pol. ASS2 7 pin ASS2 ♂ 2 x 2 pol. ASS2 2 x 2 pin ASS2
25-2901-501	1/6		●		24V		7 pol. ASS2 7 pin ASS2 ♂
25-2901-551	1/-		●		24V		7 pol. ASS2.1 7 pin ASS2.1 ♂
25-2960-001	1/6		●		24V		7 pol. ASS2.1 7 pin ASS2.1 ♂
25-2901-701	1/6		●		24V		7 pol. ASS2.1 7 pin ASS2.1 ♂
25-2960-701	1/8		●		24V		7 pol. ASS2.1 7 pin ASS2.1 ♂
25-2980-521	1/6		●		24V		7 pol. AMP 7 pin AMP ♂ 2 x 2 pol. Superseal 2 x 2 pin Superseal
25-2960-041	1/8		●		24V		7 pol. ASS2.1 7 pin ASS2.1 ♂
25-2960-701	1/8		●		24V		7 pol. ASS2.1 7 pin ASS2.1 ♂



ECOPOINT II

links mit Umrissarm
left with end outline marker

ADR Zone 2 IP 56K

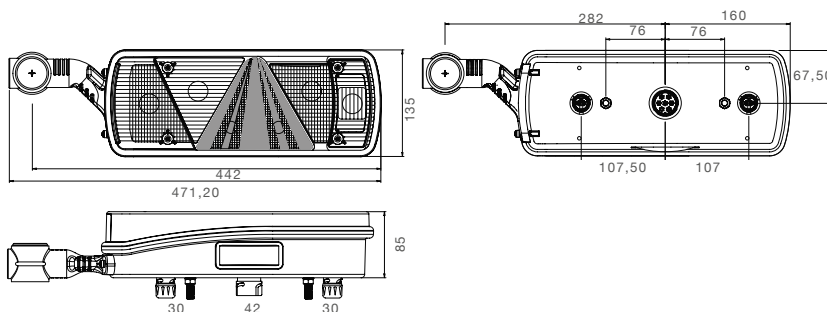

Blinklicht Direction indicator	Rücklicht Tail light	Bremslicht Stop light	Nebelschlusslicht Fog light
Rückfahrlicht Reverse light	Dreieckrückstrahler Triangle reflector	Reflektor Seitenmarkierung Reflector position light	

BEST. NR	PART NO	←	→	Light	V	Hand	ZUSATZ	ANSCHLUSS
							ADD ON	CONNECTOR
25-2810-511	1/8	●		Light	24V	Light		7 pol. ASS2 7 pin ASS2 ♂
25-2811-501	1/8	●		Light	24V	Light		7 pol. ASS2 7 pin ASS2 ♂
25-2870-401	1/-	●		Light	24V	Light		7 pol. ASS2.1 7 pin ASS2.1 ♂
25-2810-501	1/8	●		Light	24V	Light		7 pol. ASS2 7 pin ASS2 ♂
25-2831-501	1/6	●		Light	24V	lang long		7 pol. ASS2.1 7 pin ASS2.1 ♂ 2 x 2 pol. ASS2 2 x 2 pin ASS2
25-2832-501	1/6	●		Light	24V	lang long		7 pol. ASS2.1 7 pin ASS2.1 ♂
25-2810-451	1/-	●		LED	24V	lang long		7 pol. ASS2.1 7 pin ASS2.1 ♂
25-2820-741	1/-	●		LED	24V	LED lang long		7 pol. ASS2.1 7 pin ASS2.1 ♂ 2 x 2 pol. ASS2 2 x 2 pin ASS2
25-2820-501	1/8	●		Light	24V	LED		7 pol. ASS2 7 pin ASS2 ♂
25-2820-541	1/8	●		Light	24V	LED		7 pol. ASS2.1 7 pin ASS2.1 ♂ 2 x 2 pol. ASS2 2 x 2 pin ASS2
25-2880-531	1/8	●		Light	24V	LED		7 pol. AMP 7 pin AMP ♂ 2 x 2 pol. Superseal 2 x 2 pin Superseal



ECOPOINT II

rechts mit Umrissarm
right with end outline marker

ADR
Zone 2

IP 56K

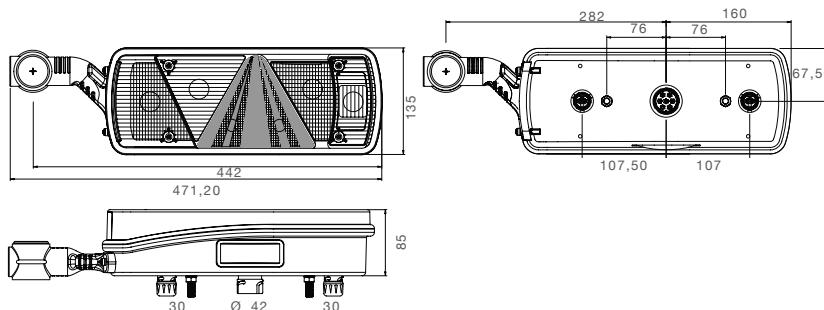

Blinklicht Direction indicator	Rücklicht Tail light	Bremslicht Stop light	Nebelschlusslicht Fog light
Rückfahrlicht Reverse light	Dreieckrückstrahler Triangle reflector	Reflektor Seitenmarkierung Reflector position light	

BEST. NR PART NO							ZUSATZ ADD ON	ANSCHLUSS CONNECTOR	
25-2910-511	1/8		●		24V			7 pol. ASS2 7 pin ASS2	2 x 2 pol. ASS2 2 x 2 pin ASS2
25-2910-551	1/-		●		24V			7 pol. ASS2.1 7 pin ASS2.1	2 x 2 pol. ASS2 2 x 2 pin ASS2
25-2911-501	1/8		●		24V			7 pol. ASS2 7 pin ASS2	
25-2911-551	1/-		●		24V			7 pol. ASS2.1 7 pin ASS2.1	
25-2970-401	1/-		●		24V			7 pol. ASS2.1 7 pin ASS2.1	
25-2910-451	1/6		●		24V	lang long		7 pol. ASS2.1 7 pin ASS2.1	
25-2931-501	1/6		●		24V	lang long		7 pol. ASS2.1 7 pin ASS2.1	2 x 2 pol. ASS2 2 x 2 pin ASS2
25-2920-741	1/-		●		24V	lang long		7 pol. ASS2.1 7 pin ASS2.1	2 x 2 pol. ASS2 2 x 2 pin ASS2
25-2932-501	1/6		●		24V	lang long		7 pol. ASS2 7 pin ASS2	
25-2920-501	1/8		●		24V			7 pol. ASS2 7 pin ASS2	
25-2920-541	1/8		●		24V			7 pol. ASS2.1 7 pin ASS2.1	2 x 2 pol. ASS2 2 x 2 pin ASS2
25-2980-531	1/8		●		24V			7 pol. AMP 7 pin AMP	2 x 2 pol. Superseal 2 x 2 pin Superseal
25-2910-501	1/8		●		24V			7 pol. ASS2 7 pin ASS2	



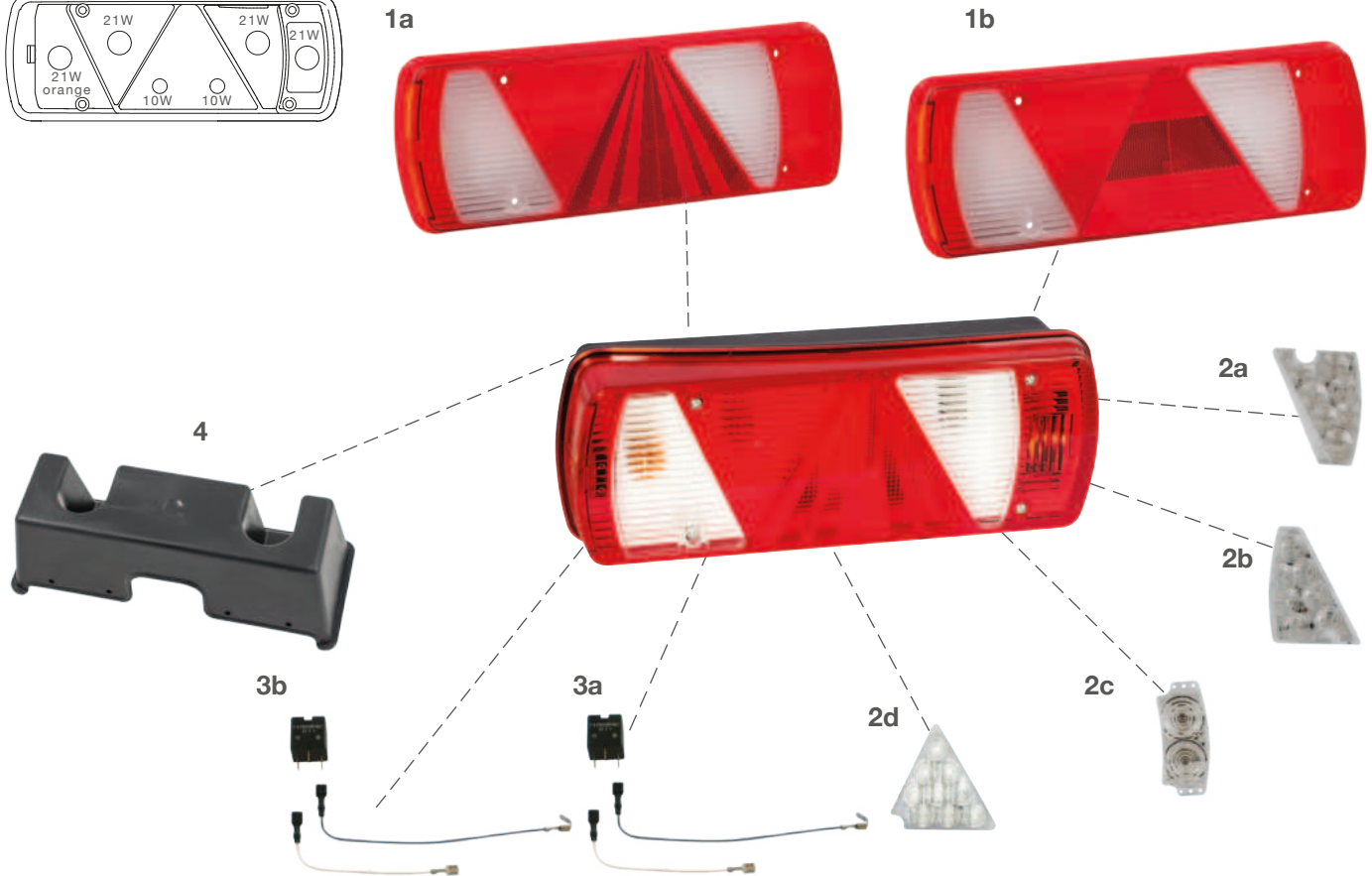
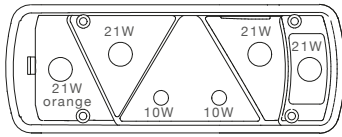

ECOPOINT II

ZUBEHÖR / ACCESSORIES





1 Lichtscheibe | lens

- (a) links
left..... 18-8528-002 
rechts
right 18-8529-002 
- (b) links ohne Dreieck
left without triangle 18-8526-002 
rechts ohne Dreieck
right without triangle 18-8527-002 

2 LED Einsätze | LED inserts

- (a) Blinklicht links ^{24V}
direction indicator left ^{24V}
..... 12-1522-154 
Blinklicht rechts ^{24V}
direction indicator right ^{24V}
..... 12-1526-154 
- (b) Rückfahrlicht links ^{24V}
reverse left ^{24V}
..... 12-1522-144 
Rückfahrlicht rechts ^{24V}
reverse right ^{24V}
..... 12-1526-144 

- (c) Nebelschlusslicht links / rechts ^{24V}
fog left / right ^{24V}
..... 12-1526-164 
- (d) Rücklicht und Bremslicht links ^{24V}
tail light and stop light left ^{24V}
..... 12-1528-001 
Rücklicht und Bremslicht rechts ^{24V}
tail light and stop light right ^{24V}
..... 12-1529-001 

3 Relais

- (a) Rückfahrwarner ^{24V}
reverse alarm ^{24V}
..... 12-3922-004 
- (b) SMCG Steuerung für Seitenmarkierungsleuchten
SMCG side marker control gear
..... 12-3970-584

4 Schutzhaube | protection cap

- 15-5277-004 



ECOPOINT II

ZUBEHÖR / ACCESSORIES



5 Umrissarm Glühlampe | outline marker bulb

- (a) links kurz
left short..... 31-3303-024
- rechts kurz
right short 31-3302-024
- (b) links lang
links long 31-3303-034
- rechts lang
rechts long..... 31-3302-034

6 Lichtscheibe Umrissarm | lens outline marker

..... 18-8141-004

7 Umrissarm LED | outline marker LED

- a) links kurz
left short..... 31-3303-044
- rechts kurz
right short 31-3302-044
- b) links lang
links long 31-3303-104
- rechts lang
rechts long..... 31-3302-104

8 ASS1 & ASS2 Verbinder | ASS1 & ASS2 connector

- (a) 2 pol. weiblich
2 pin female 13-5626-401
- (b) 7 pol. weiblich
7 pin female 13-5626-631
- (c) Verschlusskappe
closed connection 15-5623-304

9 Superseal Verbinder | Superseal connector

- 2 pol. weiblich
2 pin female 15-7002-044

10 AMP Verbinder | AMP connector

- 7 pol. weiblich
7 pin female 15-7002-024



ECOPOINT I mit Dreieck
with triangle

ADR
Zone 2

IP 54

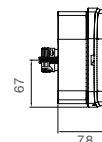
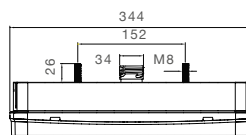
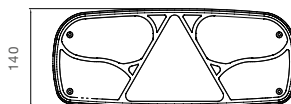

Blinklicht Direction indicator	Rücklicht Tail light	Bremslicht Stop light	Nebelschlusslicht Fog light
Rückfahrlicht Reverse light	Dreieckrückstrahler Triangle reflector		

BEST. NR	PART NO		←	→				ZUSATZ ADD ON	ANSCHLUSS CONNECTOR
25-2200-001	1/15		●			24V			7 pol. ASS2 7 pin ASS2
25-2200-701	1/15		●			24V			7 pol. ASS2 7 pin ASS2
25-2201-001	1/15		●			24V			7 pol. ASS2 7 pin ASS2
25-2600-001	1/15			●		24V			7 pol. ASS2 7 pin ASS2
25-2600-701	1/15			●		24V			7 pol. ASS2 7 pin ASS2
25-2601-001	1/15			●		24V			7 pol. ASS2 7 pin ASS2



ECOPOINT I mit Dreieck
with triangle

ADR
Zone 2

IP 54

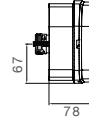
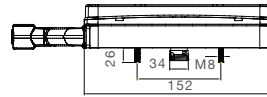
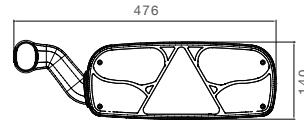

Blinklicht Direction indicator	Rücklicht Tail light	Bremslicht Stop light	Nebelschlusslicht Fog light
Rückfahrlicht Reverse light	Dreieckrückstrahler Triangle reflector		

BEST. NR							ZUSATZ	ANSCHLUSS
PART NO							ADD ON	CONNECTOR
25-2210-001	1/8	●			24V			7 pol. ASS2 7 pin ASS2 ♂
25-2210-701	1/8	●			24V			7 pol. ASS2 7 pin ASS2 ♂
25-2211-001	1/8	●			24V			7 pol. ASS2 7 pin ASS2 ♂
25-2610-001	1/8		●		24V			7 pol. ASS2 7 pin ASS2 ♂
25-2610-701	1/8		●		24V			7 pol. ASS2 7 pin ASS2 ♂
25-2611-001	1/8		●		24V			7 pol. ASS2 7 pin ASS2 ♂



ECOPOINT I mit Dreieck
with triangle

ZUBEHÖR / ACCESSORIES

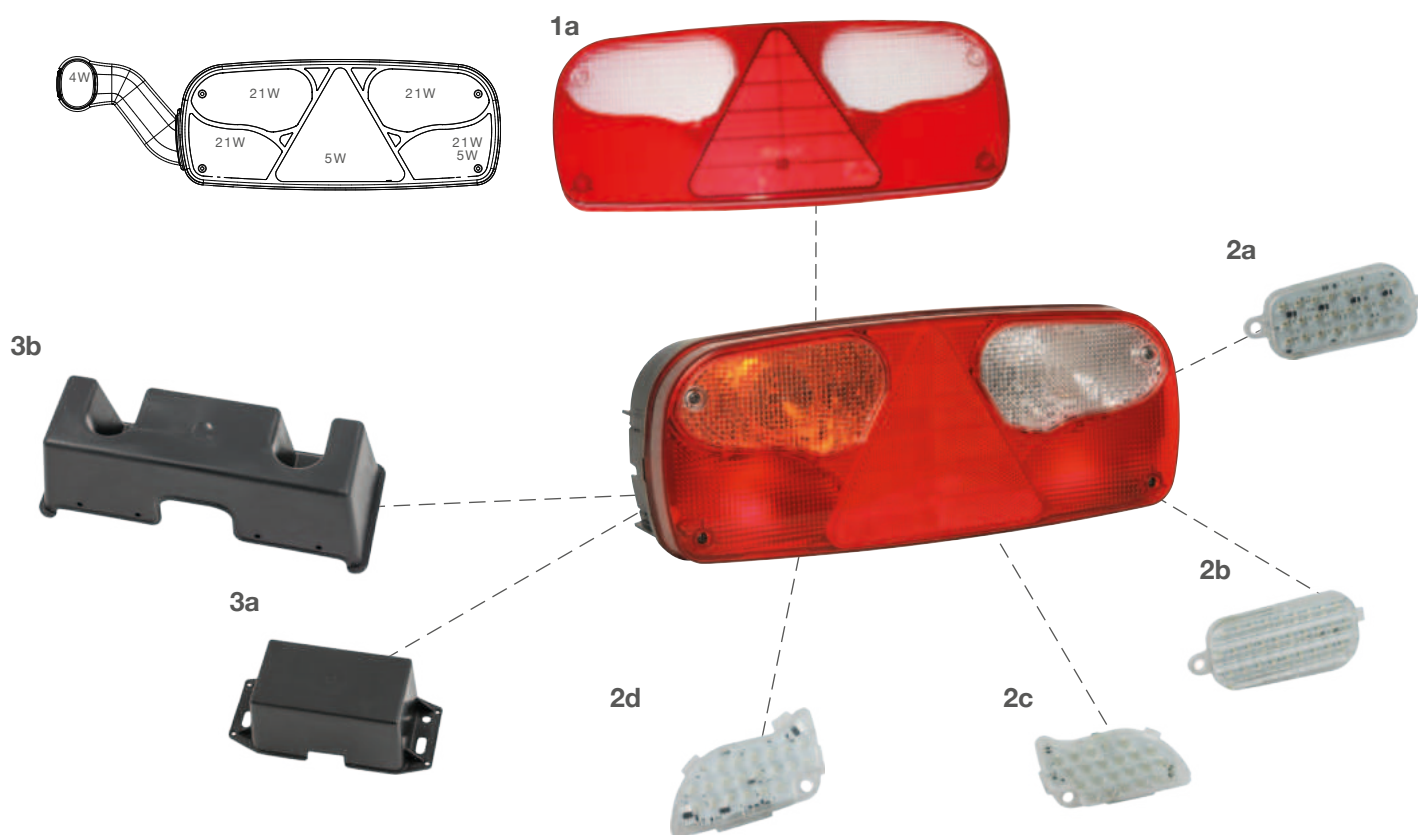

1 **Lichtscheibe | lens**
links / rechts
left / right..... 18-8522-002

2 **LED Einsätze | LED inserts**
(a) Blinklicht links 24V
direction indicator left 24V
..... 12-1522-014
Blinklicht rechts 24V
direction indicator right 24V
..... 12-1526-014
(b) Rückfahrlicht links 24V
reversing light left 24V 12-1522-034
Rückfahrlicht rechts 24V
reversing right 24V..... 12-1526-034
(c) Nebelschlusslicht links 24V
fog light left 24V..... 12-1522-024
Nebelschlusslicht rechts 24V
fog light right 24V..... 12-1526-024

(d) Rücklicht und Bremslicht links 24V
tail light and stop light left 24V
..... 12-1522-004
Rücklicht und Bremslicht rechts 24V
tail light and stop light right 24V
..... 12-1526-004

3 **Schutzhaube | protection cap**
(a) klein
small 15-5270-004
(b) groß
big 15-5276-001



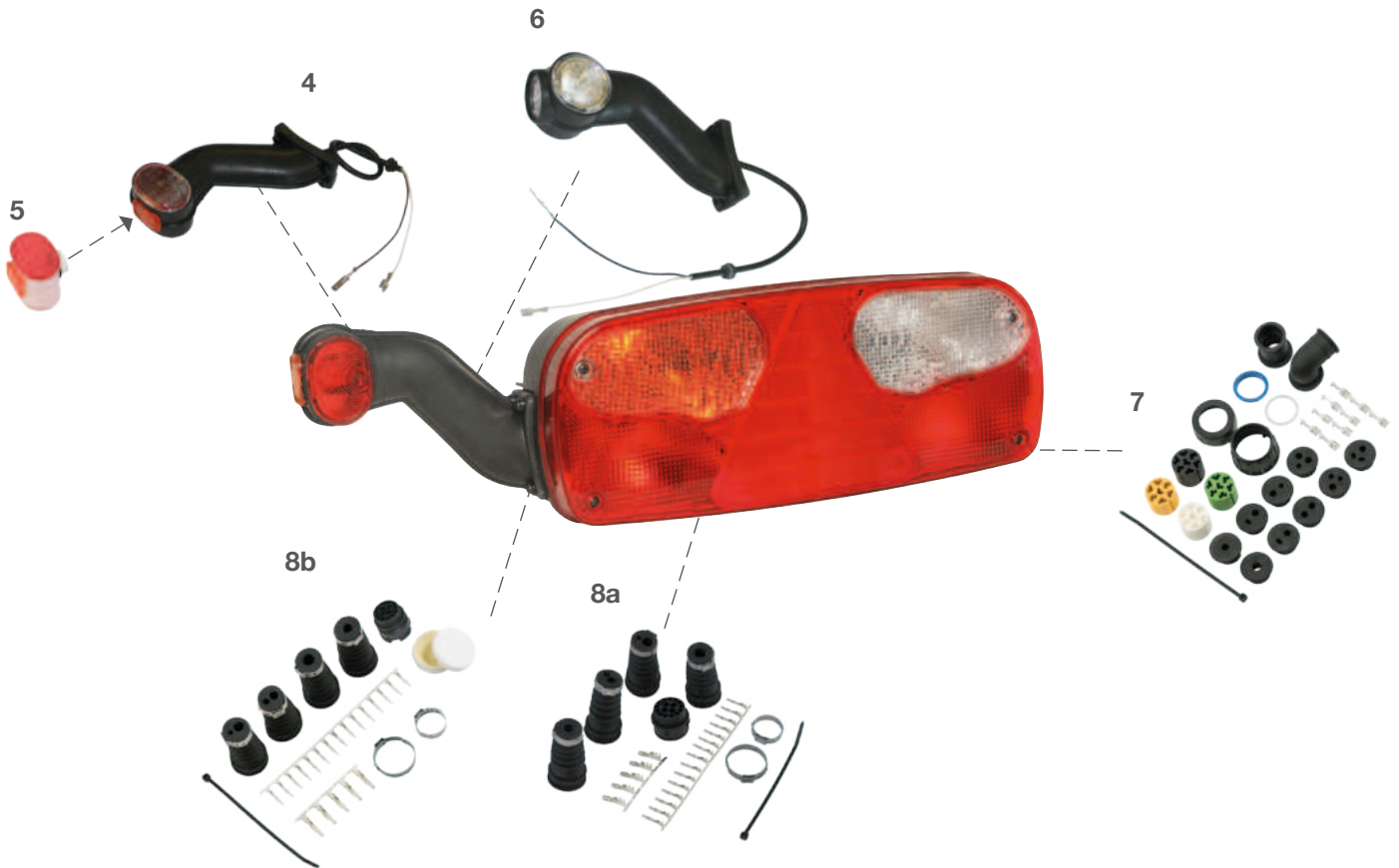

ECOPOINT | mit Dreieck
with triangle

ZUBEHÖR / ACCESSORIES



- 4** Umrissarm Glühlampe | outline marker bulb
links
left..... 31-3608-014 
rechts
right 31-3608-004 

- 5** Lichtscheibe Umrissarm | lens outline marker
..... 18-8136-004 

- 6** Umrissarm LED | outline marker LED
links
left..... 31-3305-174 
rechts
right 31-3306-174 

- 7** ASS1 & ASS2 Verbinder |
ASS1 & ASS2 connector
7 pol. weiblich
7 pin female 13-5626-631 

- 8** ASS3 Verbinder | ASS3 connector
(a) 17 pol. weiblich
17 pin female 13-1722-001 
(b) 17 pol. männlich
17 pin male 13-1732-001 

- Glühlampe | bulb
24V 5W 16-6305-027 



ECOPOINT | ohne Dreieck
without triangle

ADR
Zone 2

IP 54

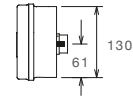
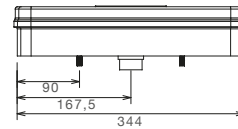
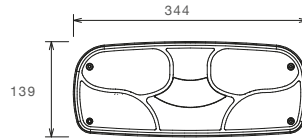

Blinklicht Direction indicator	Rücklicht Tail light	Bremslicht Stop light	Nebelschlusslicht Fog light
Rückfahrlicht Reverse light			

BEST. NR							ZUSATZ	ANSCHLUSS
PART NO							ADD ON	CONNECTOR
25-2000-501	1/15	●			24V			7 pol. ASS2 7 pin ASS2
25-2400-501	1/15		●		24V			7 pol. ASS2 7 pin ASS2



ECOPOINT | ohne Dreieck
without triangle

ZUBEHÖR / ACCESSORIES

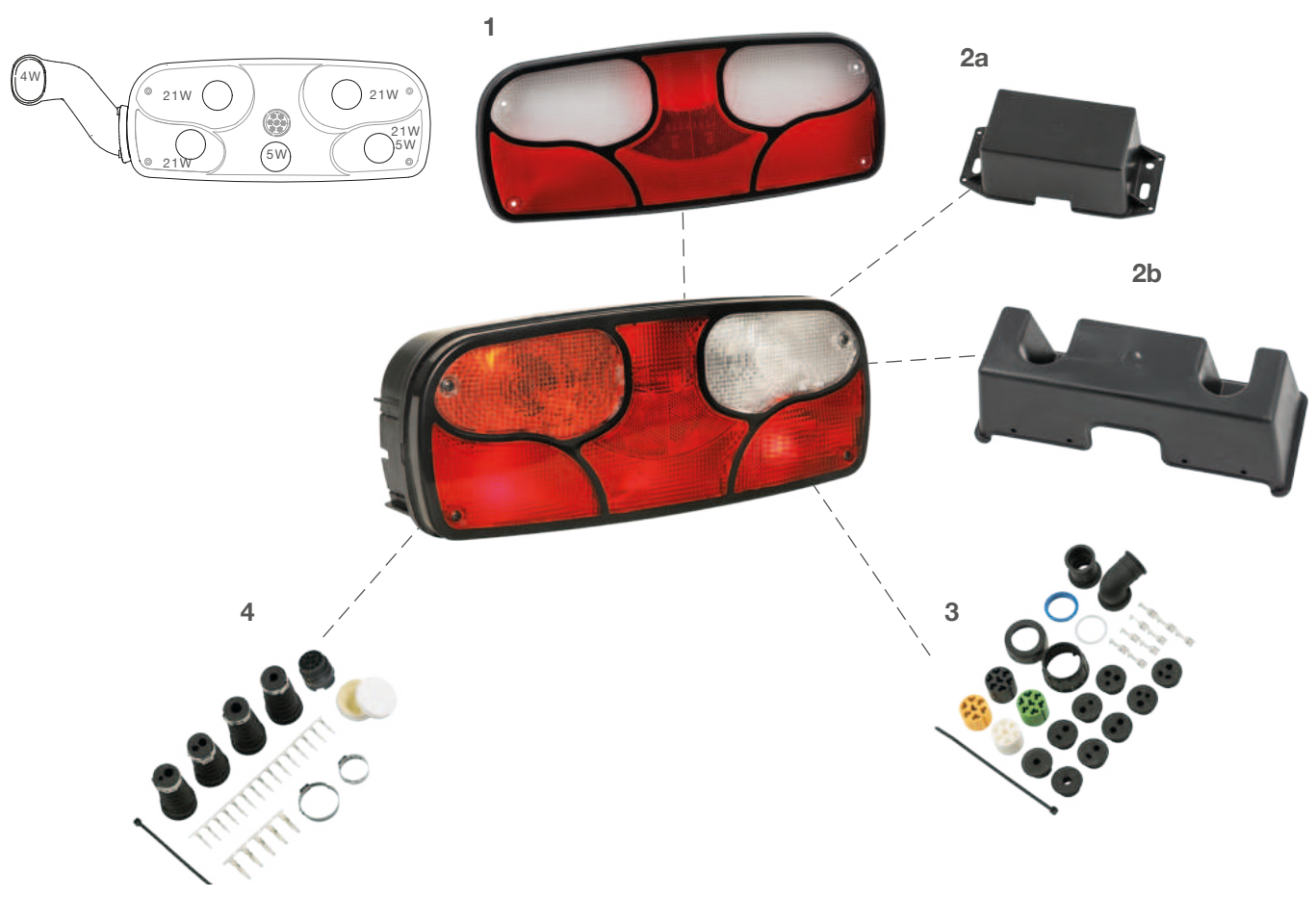

1 Lichtscheibe | lens
links / rechts
left / right..... 18-8520-002

Glühlampe | bulb
24V 5W 16-6305-027

2 Schutzhaube | protection cap
(a) klein
small 15-5270-004
(b) groß
big 15-5276-001

3 ASS1 & ASS2 Verbinder |
ASS1 & ASS2 connector
7 pol. weiblich
7 pin female 13-5626-631



ECOFLEX

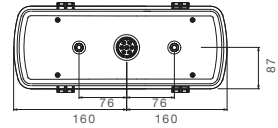
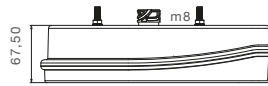
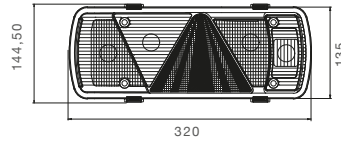

Blinklicht Direction indicator	Rücklicht Tail light	Bremslicht Stop light	Nebelschlusslicht Fog light
Rückfahrlicht Reverse light	Dreieckrückstrahler Triangle reflector		

BEST. NR	PART NO							ZUSATZ ADD ON	ANSCHLUSS CONNECTOR
25-2800-401	1/6	●			24V			7 pol. ASS2.1 7 pin ASS2.1	♂
25-2810-401	1/8	●			24V			7 pol. ASS2.1 7 pin ASS2.1	♂
25-2900-401	1/6		●		24V			7 pol. ASS2.1 7 pin ASS2.1	♂
25-2910-401	1/8		●		24V			7 pol. ASS2.1 7 pin ASS2.1	♂



ECOFLEX

ZUBEHÖR / ACCESSORIES



1 **Lichtscheibe | lens**
links
left..... 18-8528-402 
rechts
right 18-8529-402 

2 **Clip für Lichtscheibe | clip for lens**
..... 15-5323-004 

3 **LED Einsätze | LED insert**
Rücklicht / Bremslicht links
tail light / stop light left
..... 12-1528-001 
Rücklicht / Bremslicht rechts
tail light / stop light right
..... 12-1529-001 

4 **ASS1 & ASS2 Verbinder |
ASS1 & ASS2 connector**
7 pol. weiblich
7 pin female 13-5626-631 

5 **Umrissarm Glühlampe | outline marker bulb**
(a) links lang
left long..... 31-3303-034 
rechts lang
right long..... 31-3302-034 
(b) links kurz
left short..... 31-3303-024 
rechts kurz
right short 31-3302-024 



ECOFLEX

ZUBEHÖR / ACCESSORIES



6 Lichtscheibe Umrissarm | lens outline marker
..... 18-8141-004 

7 Umrissarm LED | outline marker LED

- (a) links lang
left long..... 31-3303-104 
- rechts lang
right long..... 31-3302-104 
- (b) links kurz
left short..... 31-3303-044 
- rechts kurz
right short..... 31-3302-044 



EUROFAB

ADR
Zone 2

IP 56K

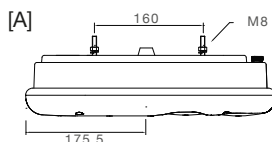
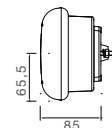
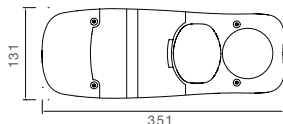

Blinklicht Direction indicator	Rücklicht Tail light	Bremslicht Stop light	Nebelschlusslicht Fog light
Rückfahrlicht Reverse light			

BEST. NR							ZUSATZ	ANSCHLUSS
PART NO							ADD ON	CONNECTOR
25-8100-001	1/10	●			12V 24V		[A]	Tülleneingang grommet
25-8100-161	1/6	●			12V		[A]	Tülleneingang grommet
25-8100-201	1/10	●			12V		[A]	7 pol. AMP 7 pin AMP
25-8100-501	1/6	●			24V		[A]	7 pol. AMP 7 pin AMP
25-8300-001	1/10		●		12V 24V		[A]	Tülleneingang grommet
25-8300-161	1/-		●		12V		[A]	Tülleneingang grommet
25-8300-201	1/10		●		12V		[A]	7 pol. AMP 7 pin AMP
25-8300-501	1/6		●		24V		[A]	7 pol. AMP 7 pin AMP



EUROFAB

ZUBEHÖR / ACCESSORIES

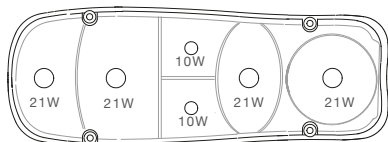

1a



1b



2



1 (a) Lichtscheibe | lens

links / rechts

left / right..... 18-8580-001 

(b) Schrauben für Lichtscheibe |

Screws for lens

..... 14-1430-454 

2 AMP Verbinder | AMP connector

7 pol. weiblich

7 pin female..... 15-7002-024 

Glühlampe | bulb

12V 21W 16-6121-017 

12V 10W 16-6110-017 



MIDILED I

ADR Zone 2 IP 6K9K



Produktinformation
Product information

[A]

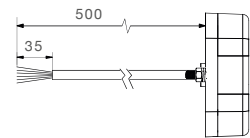
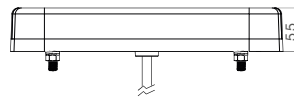
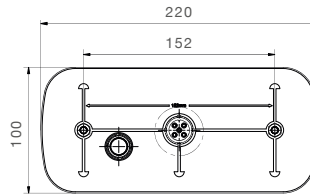

[B]

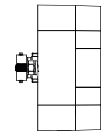
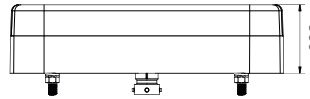

Dynamisches Blinklicht Progressive direction indicator	Rücklicht Tail light	Bremslicht Stop light	Nebelschlusslicht Fog light
Rückfahrlicht Reverse light	Dreieckrückstrahler Triangle reflector	Kennzeichenlicht Number plate holder light	

BEST. NR	PART NO	Box	←	→	Light	Voltage	ZUSATZ ADD ON	ANSCHLUSS CONNECTOR
24-3814-001	1/12	●	●	LED	12/24V		[B] 5 pol. Bajonett 5 pin Bayonet	
24-3814-011	1/12	●	●	LED	12/24V		[B] 5 pol. Bajonett 5 pin Bayonet	
34-3814-011	1/18	●	●	LED	12/24V		[A] offenes Ende open end 0,50 m	
34-3814-021	1/12	●	●	LED	12/24V		[B] offenes Ende open end 0,50 m	
34-3814-001	1/1	●	●	LED	12/24V		[A] offenes Ende open end 0,50 m	





MIDILED I

ZUBEHÖR / ACCESSORIES



1 Bajonett Verbinder | bayonet connector

- (a) 5 pol. weiblich
5 pin female 13-0521-104 
- (b) 5 pol. männlich
5 pin male 13-0536-044 



MIDILED I MAX

ADR Zone 2 IP 6K9K



Produktinformation
Product information

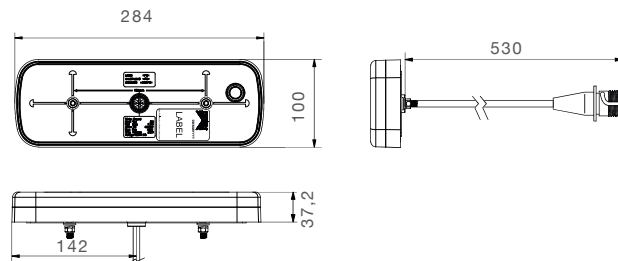

Dynamisches Blinklicht Progressive direction indicator	Rücklicht Tail light	Bremslicht Stop light	Nebelschlusslicht Fog light
Rückfahrlicht Reverse light	Dreieckrückstrahler Triangle reflector		





BEST. NR PART NO						ZUSATZ ADD ON	ANSCHLUSS CONNECTOR
35-2020-001	1/8	●	●	LED	12V		offenes Ende open end 0,50 m
35-2020-011	1/-		●	LED	12V		7 pol. ASS2 7 pin ASS2 0,50 m
35-2020-021	1/-	●		LED	12/24V		7 pol. ASS2 7 pin ASS2 0,50 m
35-2020-031	1/-	●	●	LED	12/24V		7 pol. AMP 7 pin AMP 0,50 m
35-2021-001	1/8	●	●	LED	12V		offenes Ende open end 0,50 m
35-2021-011	1/-		●	LED	12V		7 pol. ASS2 7 pin ASS2 0,50 m
35-2021-021	1/-	●		LED	12/24V		7 pol. ASS2 7 pin ASS2 0,50 m
35-2021-031	1/-	●	●	LED	12/24V		7 pol. AMP 7 pin AMP 0,50 m

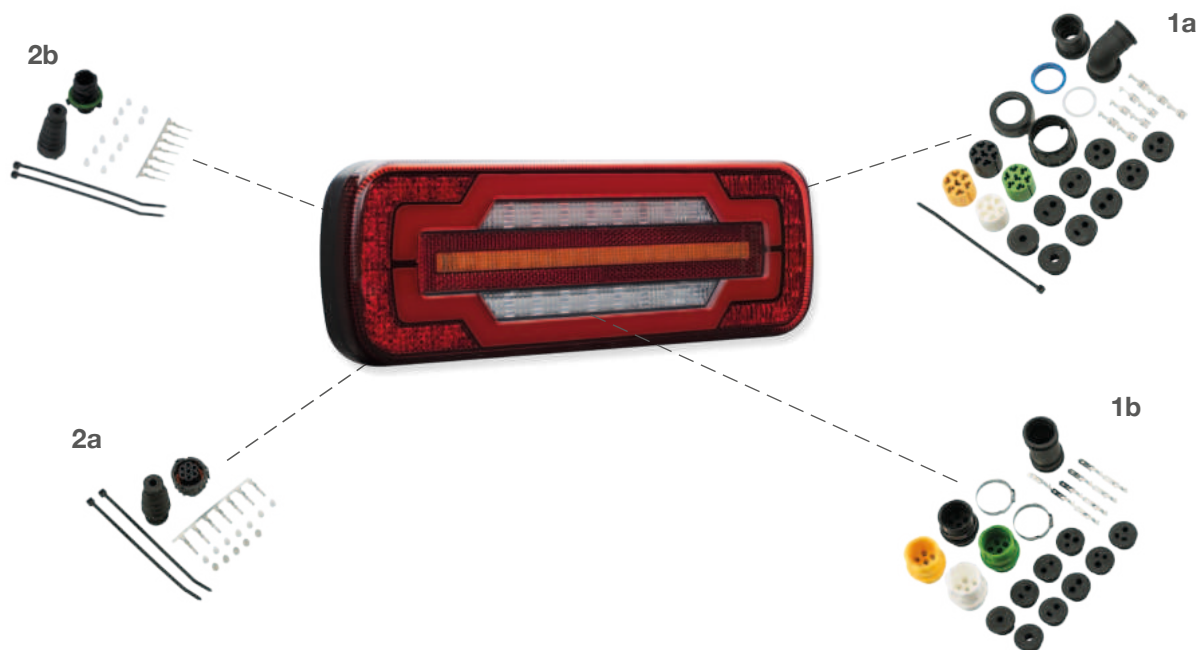

MIDILED I MAX

ZUBEHÖR / ACCESSORIES



- 1 ASS2 Verbinder | ASS2 connector**
- (a) 7 pol. weiblich
7 pin female 13-5626-631 
 - (b) 7 pol. männlich
7 pin male 13-5625-981 
- 2 AMP Verbinder | AMP connector**
- (a) 7 pol. weiblich
7 pin female 15-7002-024 
 - (b) 7 pol. männlich
7 pin male 15-7002-034 



EARPOINT LED

ADR Zone 2 IP 6K9K



Produktinformation
Product information

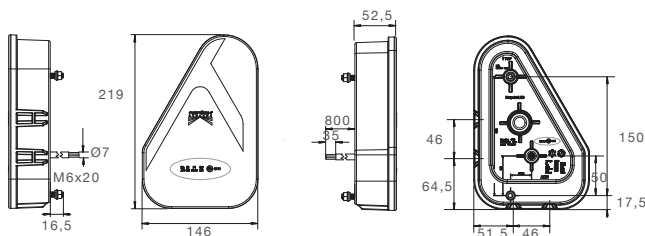

Blinklicht Direction indicator	Rücklicht Tail light	Bremslicht Stop light	Nebelschlusslicht Fog light
Rückfahrlicht Reverse light	Dreieckrückstrahler Triangle reflector		

BEST. NR		←	→	💡	⚡	🔦	ZUSATZ	ANSCHLUSS
PART NO				LED	V		ADD ON	CONNECTOR
35-0301-001	1/20	●		LED	12V 24V			offenes Ende open end 0,80 m
35-0301-011	1/12	●		LED	12V 24V			5 pol. Bajonett 5 pin Bayonet 0,80 m
35-0301-021	1/12	●		LED	12V 24V			8 pol. Bajonett 8 pin Bayonet 0,80 m
35-0301-041	1/-	●		LED	12V 24V			7 pol. ASS2 7 pin ASS2 0,80 m
35-0302-001	1/20		●	LED	12V 24V			offenes Ende open end 0,80 m
35-0302-011	1/12		●	LED	12V 24V			5 pol. Bajonett 5 pin Bayonet 0,80 m
35-0302-021	1/12		●	LED	12V 24V			8 pol. Bajonett 8 pin Bayonet 0,80 m
35-0302-041	1/-		●	LED	12V 24V			7 pol. ASS2 7 pin ASS2 0,80 m



EARPOINT LED

ZUBEHÖR / ACCESSORIES

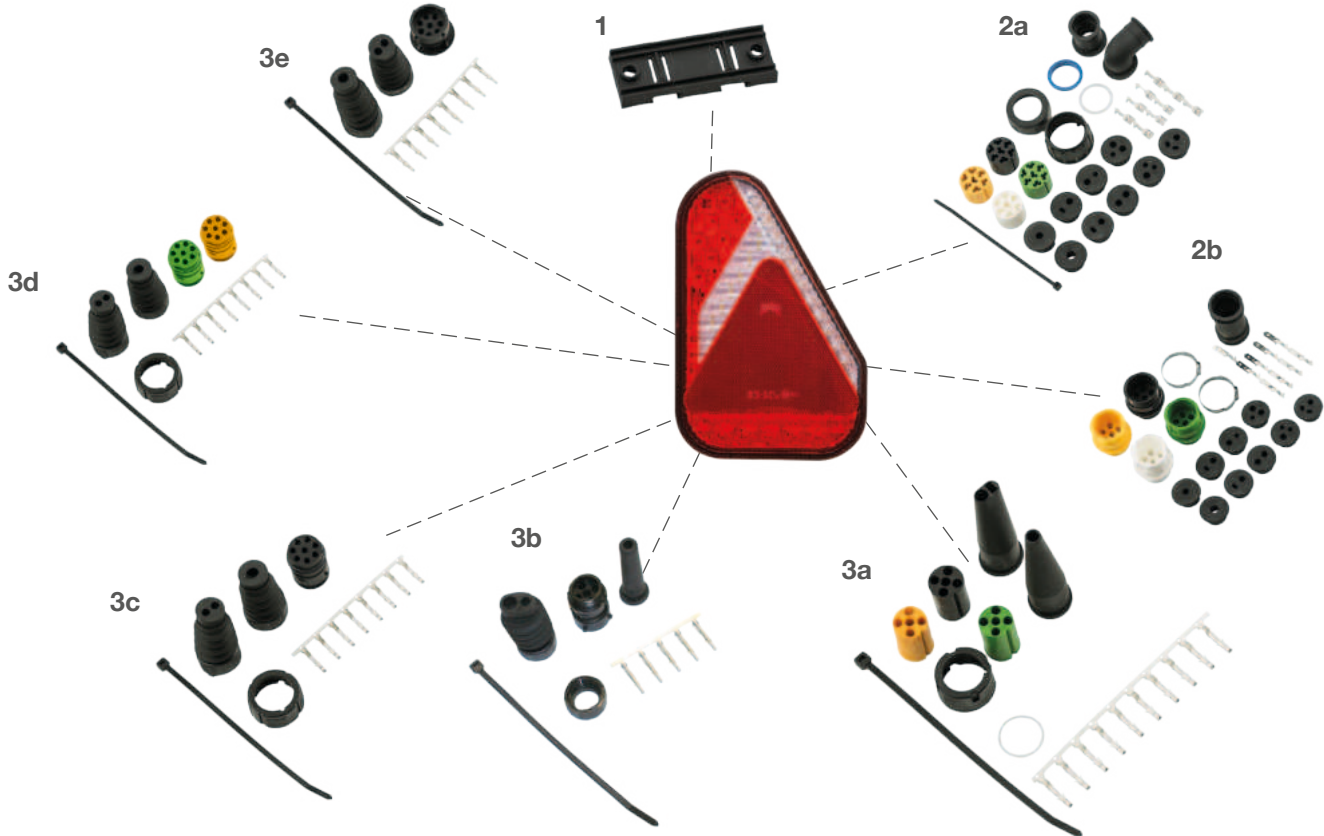

1 Halter | bracket
..... 15-5303-004

2 ASS1 & ASS2 Verbinder | ASS1 & ASS2 connector
 (a) 7 pol. weiblich
 7 pin female 13-5626-631
 (b) 7 pol. männlich
 7 pin male 13-5625-981

3 Bajonett Verbinder | bayonet connector
 (a) 5 pol. weiblich
 5 pin female 13-0521-104
 (b) 5 pol. männlich
 5 pin male 13-0536-044
 (c) 8 pol. weiblich
 8 pin female 13-0828-034
 (d) 8 pol. weiblich
 8 pin female 15-0821-524
 (d) 8 pol. männlich
 8 pin male 13-0838-054



EARPOINT I

ADR
Zone 2

IP 54

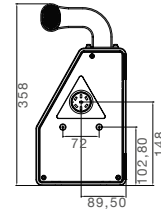
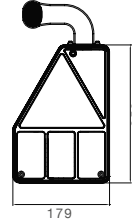
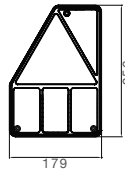

Blinklicht Direction indicator	Rücklicht Tail light	Bremslicht Stop light	
	Dreieckrückstrahler Triangle reflector		

BEST. NR							ZUSATZ	ANSCHLUSS
PART NO							ADD ON	CONNECTOR
24-4101-001	1/10	●			24V			7 pol. ASS2 7 pin ASS2
24-4105-001	1/-	●			24V			7 pol. ASS2 7 pin ASS2
24-4111-001	1/-	●			24V			PG Verschraubung cable glands
24-4151-001	1/7	●			24V			7 pol. ASS2 7 pin ASS2
24-4301-001	1/-		●		24V			7 pol. ASS2 7 pin ASS2
24-4305-001	1/20		●		24V			7 pol. ASS2 7 pin ASS2
24-4311-001	-/-		●		24V			PG Verschraubung cable glands
24-4351-001	1/6		●		24V			7 pol. ASS2 7 pin ASS2



EARPOINT I

ZUBEHÖR / ACCESSORIES

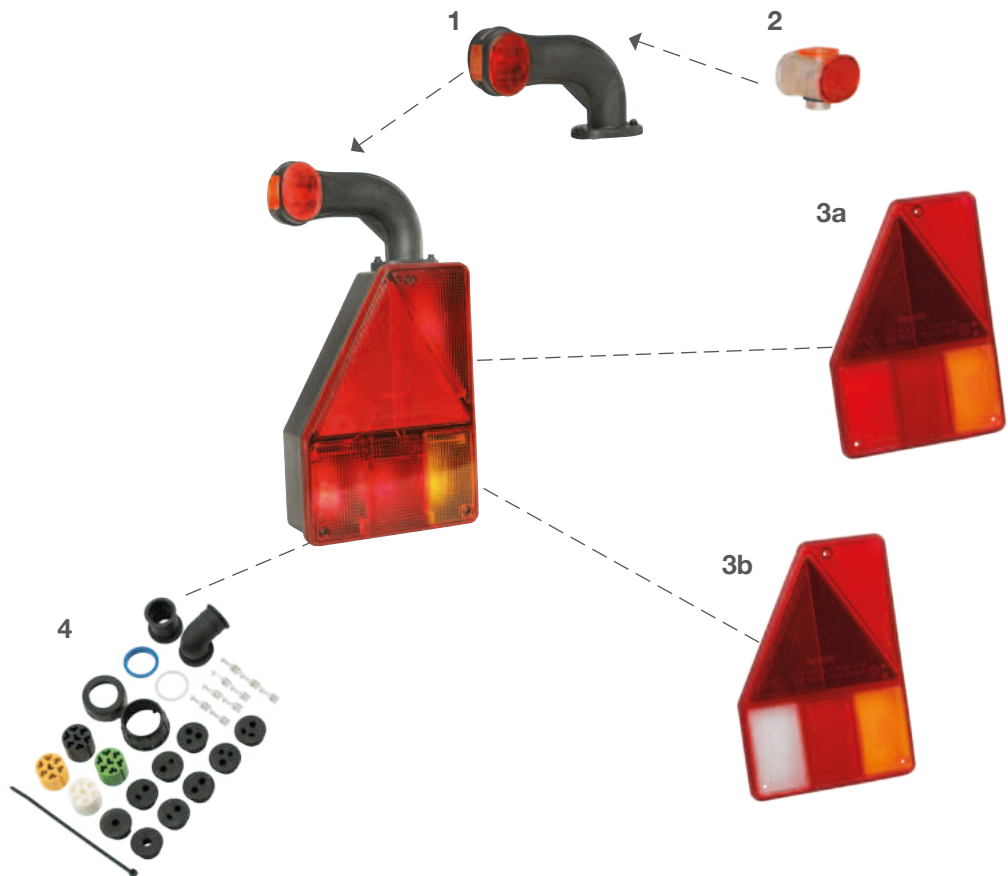
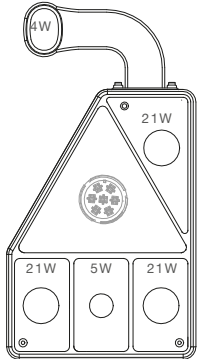

1 Umrissarm Glühlampe | outline marker bulb
..... 21-3800-004

2 Lichtscheibe Umrissarm | lens outline marker
..... 18-8136-004

3 Lichtscheibe | lens

(a) links mit left with 18-8440-001

rechts mit right with 18-8442-001

(b) links mit für left with for 18-8440-051

rechts mit right with 18-8442-101

4 ASS1 & ASS2 Verbinder |
ASS1 & ASS2 connector
7 pol. weiblich
7 pin female 13-5626-631



MULTILED IV



Produktinformation
Product information

ISO
13207-1

ADR
Zone 2

IP 56

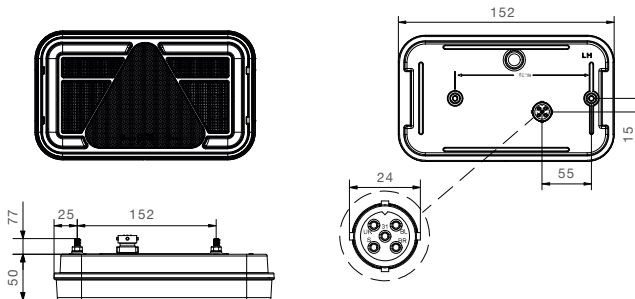

Blinklicht Direction indicator	Rücklicht Tail light	Bremslicht Stop light	Nebelschlusslicht Fog light
Rückfahrlicht Reverse light	Dreieckrückstrahler Triangle reflector	Kennzeichenlicht Number plate holder light	

BEST. NR PART NO						ZUSATZ ADD ON	ANSCHLUSS CONNECTOR
34-8941-021	1/-	●		LED	12V 24V		5 pol. Bajonett 5 pin Bayonet
34-8940-021	1/-		●	LED	12V 24V		5 pol. Bajonett 5 pin Bayonet
34-8941-031	1/-	●		LED	12V 24V		5 pol. Bajonett 5 pin Bayonet
34-8940-031	1/-		●	LED	12V 24V		5 pol. Bajonett 5 pin Bayonet
34-8941-041	1/-	●		LED	12V 24V		8 pol. Bajonett 8 pin Bayonet
34-8940-041	1/-		●	LED	12V 24V		8 pol. Bajonett 8 pin Bayonet
34-8941-051	1/-	●		LED	12V 24V		8 pol. Bajonett 8 pin Bayonet
34-8940-051	1/-		●	LED	12V 24V		8 pol. Bajonett 8 pin Bayonet
34-8941-011	1/-	●		LED	12V 24V		offenes Ende open end 0,50 m
34-8940-011	1/-		●	LED	12V 24V		offenes Ende open end 0,50 m
34-8941-001	1/-	●		LED	12V 24V		offenes Ende open end 0,50 m
34-8940-001	1/-		●	LED	12V 24V		offenes Ende open end 0,50 m



MULTILED IV

ZUBEHÖR / ACCESSORIES

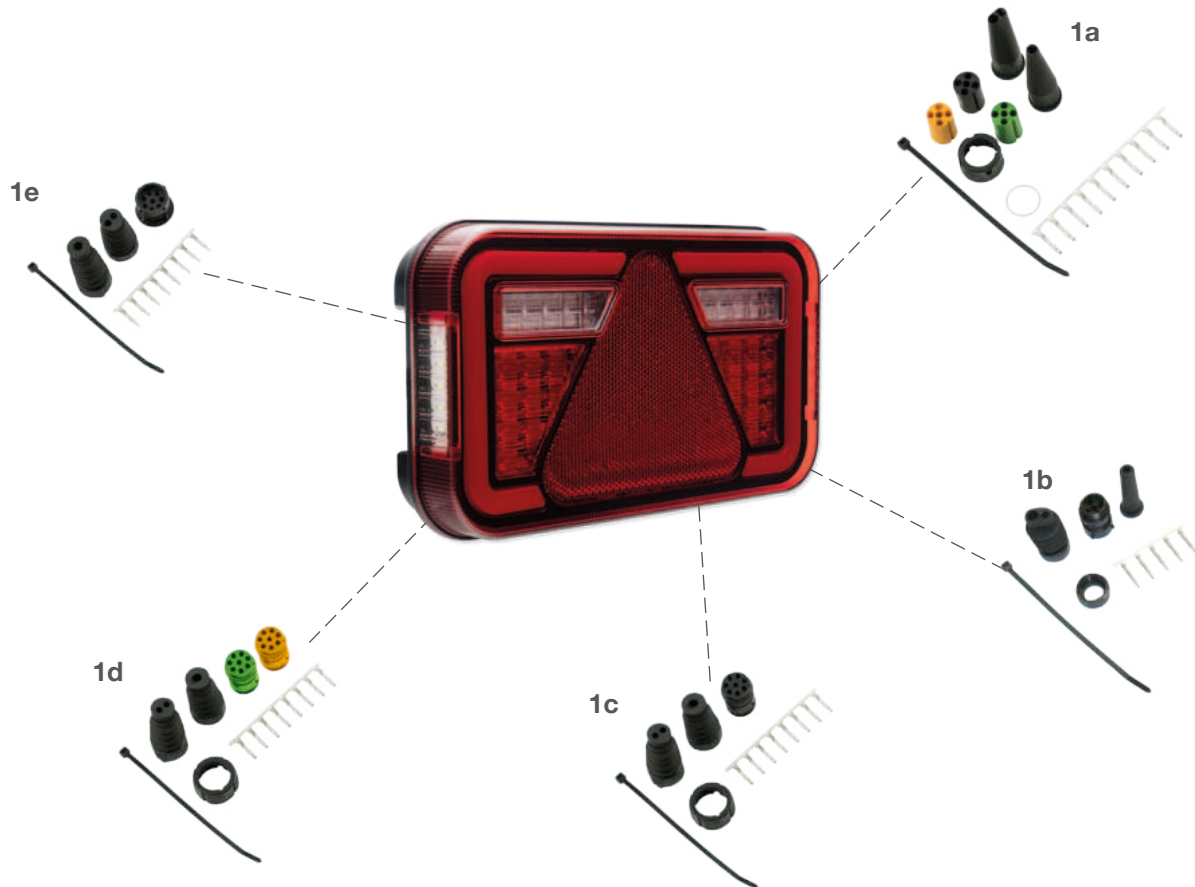

1 Bajonett Verbinder | bayonet connector

- (a) 5 pol. weiblich
5 pin female 13-0521-104
- (b) 5 pol. männlich
5 pin male 13-0536-044
- (c) 8 pol. weiblich
8 pin female 13-0828-034
- (d) 8 pol. weiblich
8 pin female 13-0821-524
- (e) 8 pol. männlich
8 pin male 13-0838-054



MULTILED III TRAILER



Produktinformation
Product information

ISO
13207-1

ADR
Zone 2

IP 56

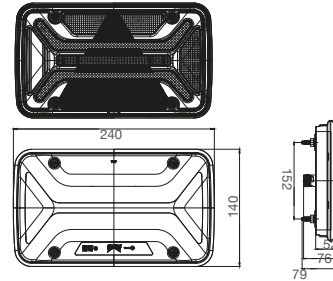

Blinklicht Direction indicator	Rücklicht Tail light	Bremslicht Stop light	Nebelschlusslicht Fog light
Rückfahrlicht Reverse light	Dreieckrückstrahler Triangle reflector		

BEST. NR		←	→	💡	⚡	👉	ZUSATZ	ANSCHLUSS	
PART NO				LED	V		ADD ON	CONNECTOR	
24-8931-001	1/-	●		LED	12V 24V			7 pol. ASS2 7 pin ASS2	♂
24-8930-001	1/-		●	LED	12V 24V			7 pol. ASS2 7 pin ASS2	♂
24-8931-011	1/-	●		LED	12V 24V			7 pol. ASS2 7 pin ASS2	♂ 2 pol. ASS2 2 pin ASS2
24-8930-011	1/-		●	LED	12V 24V			7 pol. ASS2 7 pin ASS2	♂ 2 pol. ASS2 2 pin ASS2
24-8931-021	1/-	●		LED	12V 24V			7 pol. ASS2 7 pin ASS2	♂ 2 pol. ASS2 2 pin ASS2
24-8930-021	1/-		●	LED	12V 24V			7 pol. AMP 7 pin AMP	♂ 2 pol. ASS2 2 pin ASS2
24-8931-041	1/-	●		LED	12V 24V			7 pol. AMP 7 pin AMP	♂
24-8930-041	1/-		●	LED	12V 24V			7 pol. AMP 7 pin AMP	♂
24-8931-031	1/-	●		LED	12V 24V			7 pol. AMP 7 pin AMP	♂ 2 pol. ASS2 2 pin ASS2
24-8930-031	1/-		●	LED	12V 24V			7 pol. AMP 7 pin AMP	♂ 2 pol. ASS2 2 pin ASS2
24-8931-051	1/-	●		LED	12V 24V			7 pol. AMP 7 pin AMP	♂ 2 pol. Superseal 2 pin Superseal
24-8930-051	1/-		●	LED	12V 24V			7 pol. AMP 7 pin AMP	♂ 2 pol. Superseal 2 pin Superseal
24-8931-061	1/-	●		LED	12V 24V			7 pol. AMP 7 pin AMP	♂ 2 pol. Superseal 2 pin Superseal
24-8930-061	1/-		●	LED	12V 24V			7 pol. AMP 7 pin AMP	♂ 2 pol. Superseal 2 pin Superseal



MULTILED III TRUCK



Produktinformation
Product information

ISO
13207-1

ADR
Zone 2

IP 56

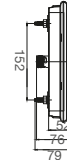
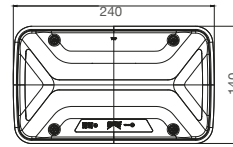
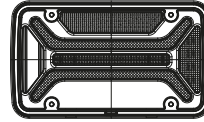

Blinklicht Direction indicator	Rücklicht Tail light	Bremslicht Stop light	Nebelschlusslicht Fog light
Rückfahrlicht Reverse light			

BEST. NR		←	→	💡	⚡	ZUSATZ	ANSCHLUSS
PART NO						ADD ON	CONNECTOR
24-8931-071	1/-	●		LED	12V 24V		7 pol. AMP 7 pin AMP ♂
24-8930-071	1/-		●	LED	12V 24V		7 pol. AMP 7 pin AMP ♂
24-8931-081	1/-	●		LED	12V 24V		7 pol. AMP 7 pin AMP ♂ 2 pol. ASS2 2 pin ASS2
24-8930-081	1/-		●	LED	12V 24V		7 pol. AMP 7 pin AMP ♂ 2 pol. ASS2 2 pin ASS2



MULTILED III TRAILER

ZUBEHÖR / ACCESSORIES



- 1** Lichtscheibe | lens
mit Dreieck
with triangle 24-8937-001 
ohne Dreieck
without triangle 24-8937-011 

- 2** ASS1 & ASS2 Verbinder |
ASS1 & ASS2 connector
(a) 2 pol. weiblich
2 pin female 13-5626-401 
(b) 7 pol. weiblich
7 pin female 13-5626-631 
(c) Verschlusskappe
closed connection 15-5623-304 

- 3** AMP Verbinder |
AMP connector
7 pol. weiblich
7 pin female 15-7002-024 

- 4** Superseal Verbinder |
Superseal connector
2 pol. weiblich
2 pin female 15-7002-044 

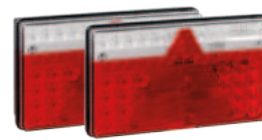

MULTILED II hoch / high

ADR Zone 2 IP 6K9K



Produktinformation
Product information

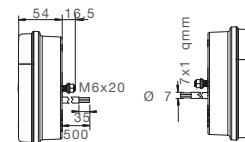
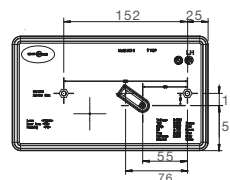
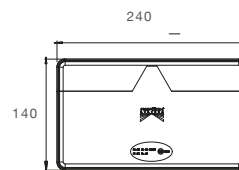

Blinklicht Direction indicator	Rücklicht Tail light	Bremslicht Stop light	Nebelschlusslicht Fog light
Rückfahrlicht Reverse light	Dreieckrückstrahler Triangle reflector		

BEST. NR						ZUSATZ ADD ON	ANSCHLUSS CONNECTOR
PART NO				LED	12V 24V		
35-0203-001	1/-	●		LED	12V 24V		offenes Ende open end 0,50 m
35-0203-011	1/-	●		LED	12V 24V		5 pol. Bajonett 5 pin Bayonet 0,50 m
35-0203-021	1/-	●		LED	12V 24V		8 pol. Bajonett 8 pin Bayonet 0,50 m
35-0203-031	1/-	●		LED	12V 24V		7 pol. ASS2 7 pin ASS2 0,50 m
35-0203-041	1/-	●		LED	12V 24V		7 pol. AMP 7 pin AMP 0,50 m
35-0203-051	1/-	●		LED	12V 24V		offenes Ende open end 0,50 m
35-0203-061	1/-	●		LED	12V 24V		5 pol. Bajonett 5 pin Bayonet 0,50 m
35-0203-071	1/-	●		LED	12V 24V		8 pol. Bajonett 8 pin Bayonet 0,50 m
35-0203-081	1/-	●		LED	12V 24V		7 pol. ASS2 7 pin ASS2 0,50 m
35-0203-091	1/-	●		LED	12V 24V		7 pol. AMP 7 pin AMP 0,50 m
35-0203-101	1/-	●		LED	12V 24V		offenes Ende open end 0,50 m
35-0203-111	1/-	●		LED	12V 24V		5 pol. Bajonett 5 pin Bayonet 0,50 m
35-0203-121	1/5	●		LED	12V 24V		8 pol. Bajonett 8 pin Bayonet 0,50 m
35-0203-131	1/-	●		LED	12V 24V		7 pol. ASS2 7 pin ASS2 0,50 m
35-0203-141	1/-	●		LED	12V 24V		7 pol. AMP 7 pin AMP 0,50 m



MULTILED II hoch / high



Produktinformation
Product information

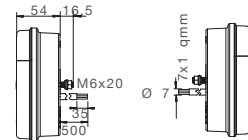
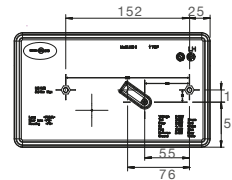
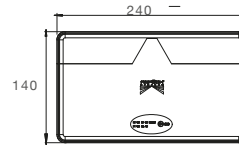
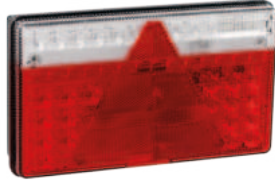

Blinklicht Direction indicator	Rücklicht Tail light	Bremslicht Stop light	Nebelschlusslicht Fog light
Rückfahrlicht Reverse light	Dreieckrückstrahler Triangle reflector		

BEST. NR	PART NO						ZUSATZ ADD ON	ANSCHLUSS CONNECTOR
35-0204-001	1/-		●	LED	12V 24V		offenes Ende open end 0,50 m	
35-0204-011	1/-		●	LED	12V 24V		5 pol. Bajonett 5 pin Bayonet 0,50 m	
35-0204-021	1/5		●	LED	12V 24V		8 pol. Bajonett 8 pin Bayonet 0,50 m	
35-0204-051	1/-		●	LED	12V 24V		offenes Ende open end 0,50 m	
35-0204-031	1/-		●	LED	12V 24V		7 pol. ASS2 7 pin ASS2 0,50 m	
35-0204-041	1/-		●	LED	12V 24V		7 pol. AMP 7 pin AMP 0,50 m	
35-0204-061	1/-		●	LED	12V 24V		5 pol. Bajonett 5 pin Bayonet 0,50 m	
35-0204-071	1/-		●	LED	12V 24V		8 pol. Bajonett 8 pin Bayonet 0,50 m	
35-0204-081	1/-		●	LED	12V 24V		7 pol. ASS2 7 pin ASS2 0,50 m	
35-0204-091	1/-		●	LED	12V 24V		7 pol. AMP 7 pin AMP 0,50 m	
35-0204-101	1/-		●	LED	12V 24V		offenes Ende open end 0,50 m	
35-0204-111	1/-		●	LED	12V 24V		5 pol. Bajonett 5 pin Bayonet 0,50 m	
35-0204-121	1/5		●	LED	12V 24V		8 pol. Bajonett 8 pin Bayonet 0,50 m	
35-0204-131	1/-		●	LED	12V 24V		7 pol. ASS2 7 pin ASS2 0,50 m	
35-0204-141	1/-		●	LED	12V 24V		7 pol. AMP 7 pin AMP 0,50 m	

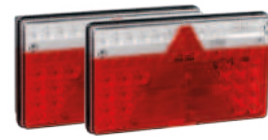

MULTILED II flach / flat



Produktinformation
Product information

ADR Zone 2 IP 6K9K

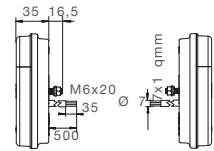
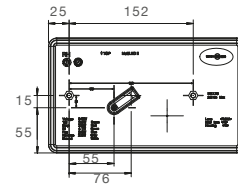
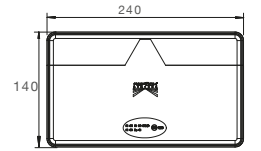
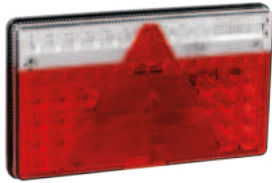

Blinklicht Direction indicator	Rücklicht Tail light	Bremslicht Stop light	Nebelschlusslicht Fog light
Rückfahrlicht Reverse light	Dreieckrückstrahler Triangle reflector		

BEST. NR		←	→				ZUSATZ	ANSCHLUSS	0,50 m	
PART NO							ADD ON	CONNECTOR		
35-0201-001	1/-	●		LED	12V 24V			offenes Ende open end		
35-0201-011	1/-	●		LED	12V 24V			5 pol. Bajonett 5 pin Bayonet		
35-0201-021	1/-	●		LED	12V 24V			8 pol. Bajonett 8 pin Bayonet		
35-0201-031	1/-	●		LED	12V 24V			7 pol. ASS2 7 pin ASS2		
35-0201-041	1/-	●		LED	12V 24V			7 pol. AMP 7 pin AMP		
35-0202-001	1/-			LED	12V 24V			offenes Ende open end		
35-0202-011	1/-			LED	12V 24V			5 pol. Bajonett 5 pin Bayonet		
35-0202-021	1/-			LED	12V 24V			8 pol. Bajonett 8 pin Bayonet		
35-0202-031	1/-			LED	12V 24V			7 pol. ASS2 7 pin ASS2		
35-0202-041	1/-			LED	12V 24V			7 pol. AMP 7 pin AMP		



MULTILED II

ZUBEHÖR / ACCESSORIES

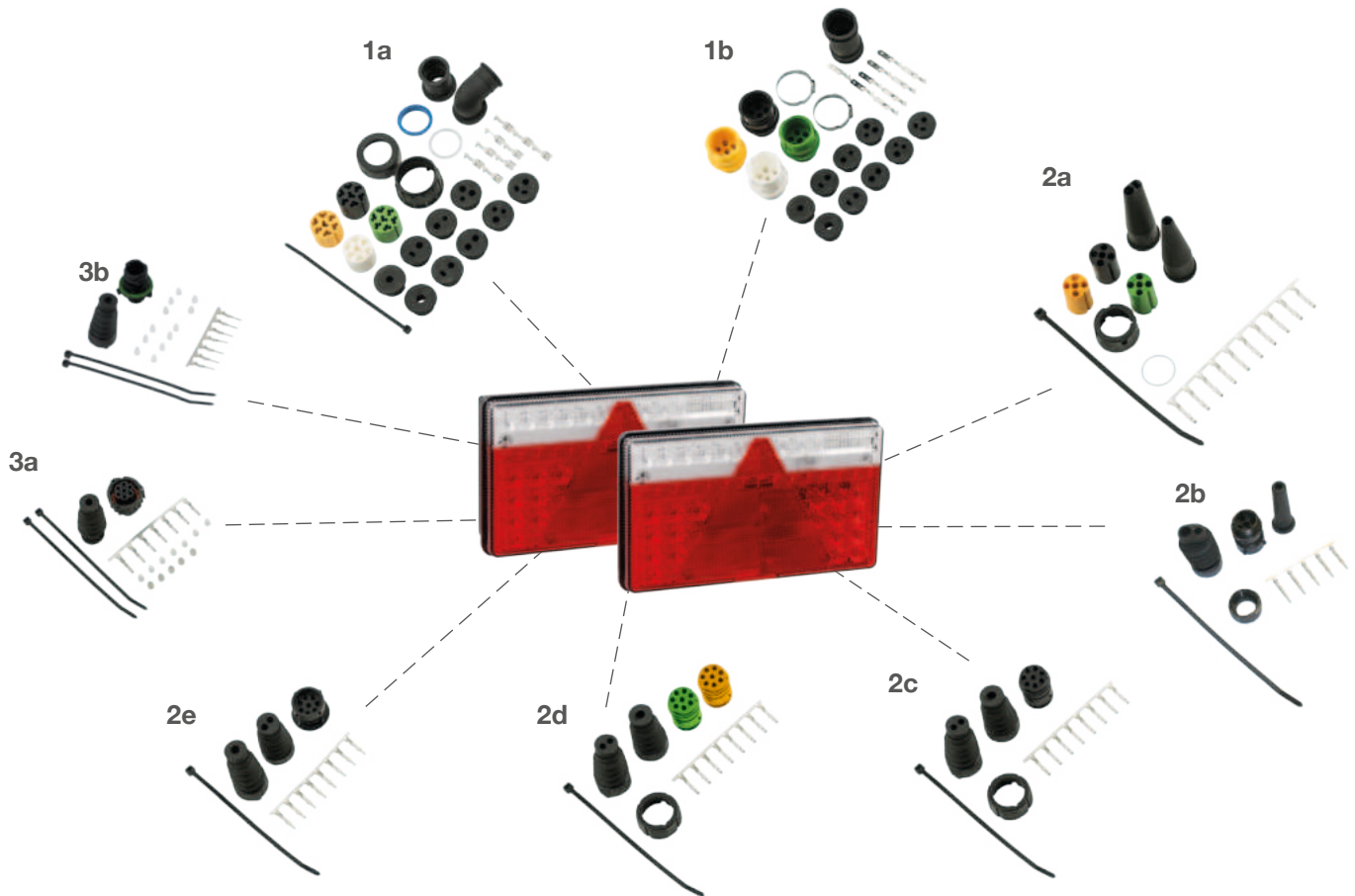

1 ASS1 & ASS2 Verbinder | ASS1 & ASS2 connector

- (a) 7 pol. weiblich
7 pin female 13-5626-631
- (b) 7 pol. männlich
7 pin male 13-5625-981

2 Bajonett Verbinder | bayonet connector

- (a) 5 pol. weiblich
5 pin female 13-0521-104
- (b) 5 pol. männlich
5 pol. male 13-0536-044
- (c) 8 pol. weiblich
8 pin female 13-0828-034
- (d) 8 pol. weiblich
8 pin female 15-0821-524
- (e) 8 pol. männlich
8 pol. male 13-0838-054

3 AMP Verbinder | AMP connector

- (a) 7 pol. weiblich
7 pin female 15-7002-024
- (b) 7 pol. männlich
7 pin male 15-7002-034



MULTILED

ADR Zone 2 IP69K

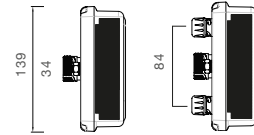
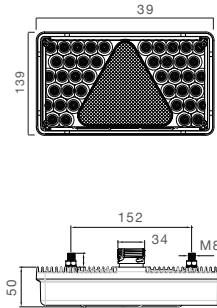

Blinklicht Direction indicator	Rücklicht Tail light	Bremslicht Stop light	Nebelschlusslicht Fog light
Rückfahrlicht Reverse light	Dreieckrückstrahler Triangle reflector	Seitenmarkierungslicht + Reflektor Sidemarker light + reflector	

BEST. NR						ZUSATZ	ANSCHLUSS
PART NO						ADD ON	CONNECTOR
24-7400-701	1/-	●		LED	24V		7 pol. ASS2.1 7 pin ASS2.1
24-7430-701	1/10	●		LED	24V		7 pol. AMP 7 pin AMP 1 x 2 pol. ASS2 1 x 2 pin ASS2
24-7470-701	1/-	●		LED	24V		7 pol. AMP 7 pin AMP 1 x 2 pol. ASS2 1 x 2 pin ASS2
24-7630-701	1/10	●		LED	24V	Plastikgehäuse plastic housing	7 pol. AMP 7 pin AMP 1 x 2 pol. ASS2 1 x 2 pin ASS2
24-7500-701	1/10		●	LED	24V		7 pol. ASS2.1 7 pin ASS2.1
24-7530-701	1/10		●	LED	24V		7 pol. AMP 7 pin AMP 1 x 2 pol. ASS2 1 x 2 pin ASS2
24-7570-701	1/-		●	LED	24V		7 pol. AMP 7 pin AMP 1 x 2 pol. ASS2 1 x 2 pin ASS2
24-7730-701	1/10		●	LED	24V	Plastikgehäuse plastic housing	7 pol. AMP 7 pin AMP 1 x 2 pol. ASS2 1 x 2 pin ASS2



MULTILED

ZUBEHÖR / ACCESSORIES

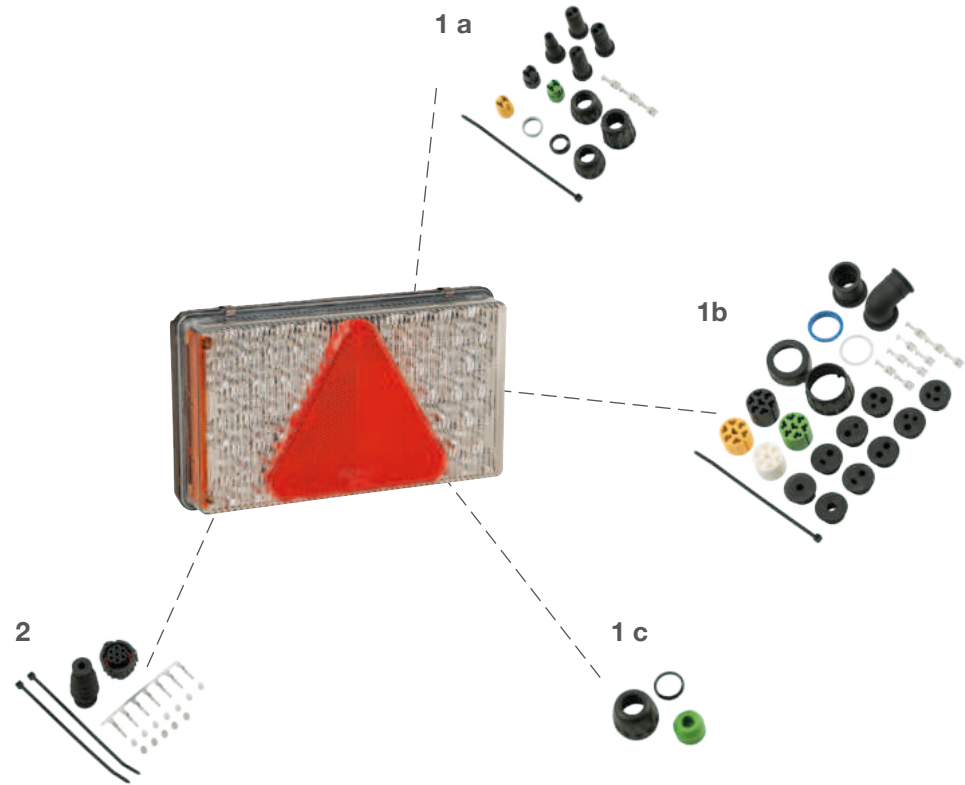

1 ASS1 & ASS2 Verbinder | ASS1 & ASS2 connector

- (a) 2 pol. weiblich
2 pin female 13-5626-401
- (b) 7 pol. weiblich
7 pin female 13-5626-631
- (c) Verschlusskappe
closed connection 15-5623-304

2 AMP Verbinder | AMP connector

- 7 pol. weiblich
7 pin female 15-7002-024

LED Vorschaltgerät | LED control gear

- LCG siehe Seite 188
- see at page 188



MULTIPOINT V

ADR Zone 2

IP 54

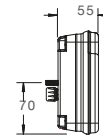
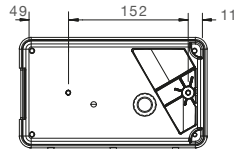
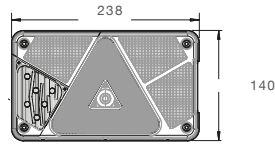

Blinklicht Direction indicator	Rücklicht Tail light	Bremslicht Stop light	Nebelschlusslicht Fog light
Rückfahrlicht Reverse light			

BEST. NR	PART NO							ZUSATZ ADD ON	ANSCHLUSS CONNECTOR
24-8502-001	1/-	●			24V			PG Verschraubung cable glands	
24-8504-701	1/10	●			24V			PG Verschraubung cable glands	
34-8503-001	1/-	●			24V			7 pol. AMP 7 pin AMP	0,15 m
34-8505-001	1/10	●			24V			7 pol. ASS2 7 pin ASS2	2,50 m
34-8605-001	1/12	●			24V			7 pol. ASS2 7 pin ASS2	0,90 m
24-8702-001	1/-		●		24V			PG Verschraubung cable glands	
24-8714-701	1/10		●		24V			PG Verschraubung cable glands	
34-8702-001	1/-		●		24V			7 pol. AMP 7 pin AMP	0,15 m
34-8706-001	1/4		●		24V			7 pol. ASS2 7 pin ASS2	2,50 m
34-8806-001	1/12		●		24V			7 pol. ASS2 7 pin ASS2	0,90 m



MULTIPOINT V

ZUBEHÖR / ACCESSORIES

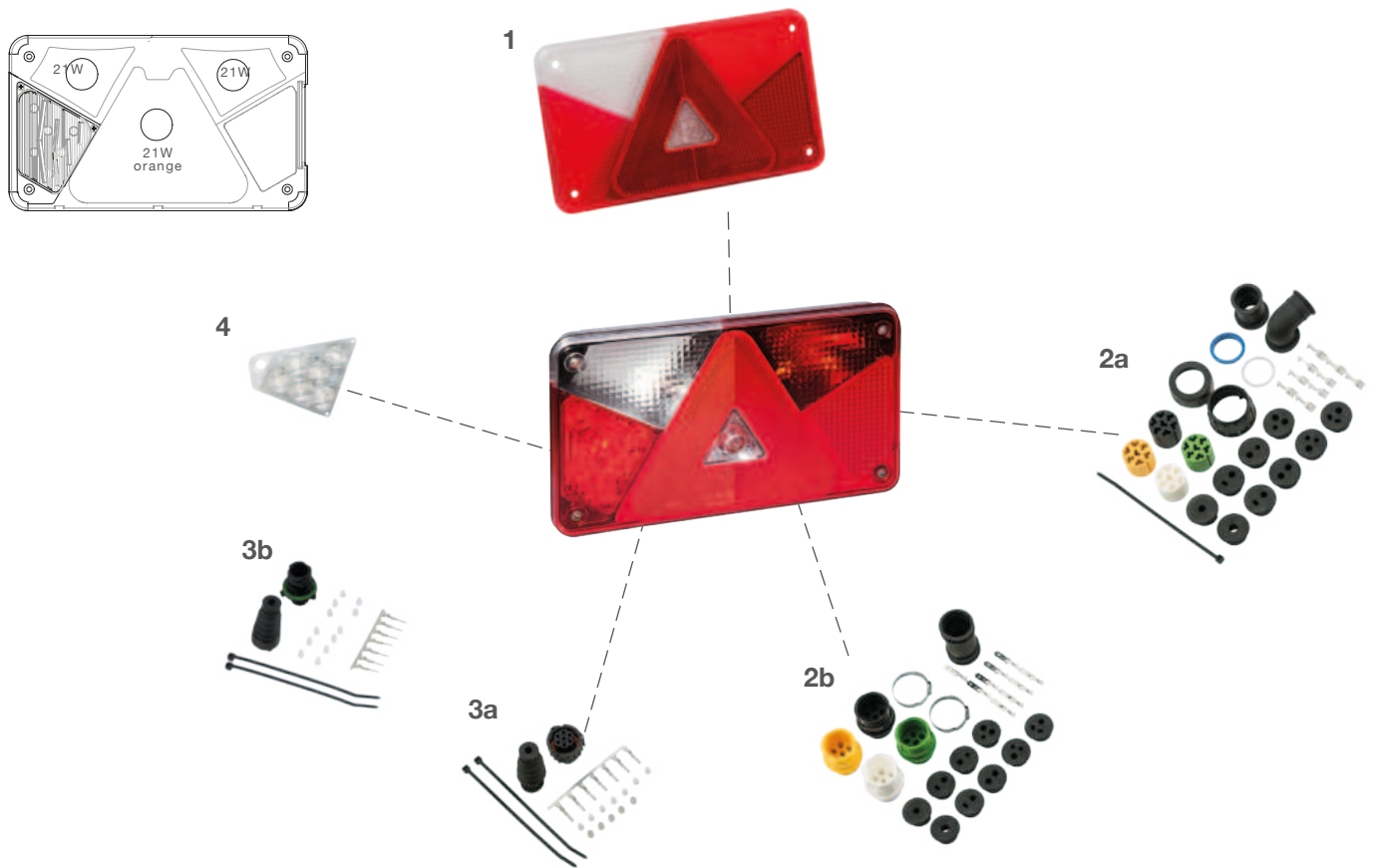

- 1** **Lichtscheibe | lens**
 links
 left..... 18-8485-004 
 rechts
 right 18-8487-004 

- 2** **ASS1 & ASS2 Verbinder | ASS1 & ASS2 connector**
 (a) 7 pol. weiblich
 7 pin female 13-5626-631 
 (b) 7 pol. männlich
 7 pin male 13-5625-981 

- 3** **AMP Verbinder | AMP connector**
 (a) 7 pol. weiblich
 7 pin female 15-7002-024 
 (b) 7 pol. männlich
 7 pin male 15-7002-034 

- 4** **LED Einsätze | LED insert**
 Rücklicht / Bremslicht links
 tail light / stop light left
 12-1530-004 
 Rücklicht / Bremslicht rechts
 tail light / stop light right
 12-1531-004 



MULTIPOINT LED

ADR Zone 2 IP 54

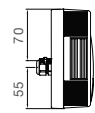
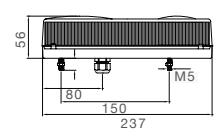
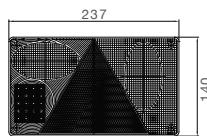

Blinklicht Direction indicator	Rücklicht Tail light	Bremslicht Stop light	
		Seitenmarkierungslicht + Reflektor Sidemarker light + reflector	

BEST. NR		←	→				ZUSATZ	ANSCHLUSS
PART NO							ADD ON	CONNECTOR
24-5700-721	1/10	●			24V			
34-5703-001	1/10	●			24V		8 pol. Bajonett 8 pin Bayonet	1,80 m
34-5703-011	1/-	●			24V		8 pol. Bajonett 8 pin Bayonet	1,80 m
34-5705-001	1/-	●			24V		7 pol. ASS2 7 pin ASS2	2,50 m
24-5800-731	1/10		●		24V		PG 11 Verschraubung cable glands 11	
24-5805-711	1/-		●		24V		Tülleneingang grommet	
24-5813-701	1/-		●		24V		Tülleneingang grommet	
34-5802-001	1/10		●		24V		8 pol. Bajonett 8 pin Bayonet	1,80 m
34-5802-011	1/-		●		24V		8 pol. Bajonett 8 pin Bayonet	2,50 m
34-5806-001	1/-		●		24V		7 pol. ASS2 7 pin ASS2	2,50 m



MULTIPOINT LED

ZUBEHÖR / ACCESSORIES

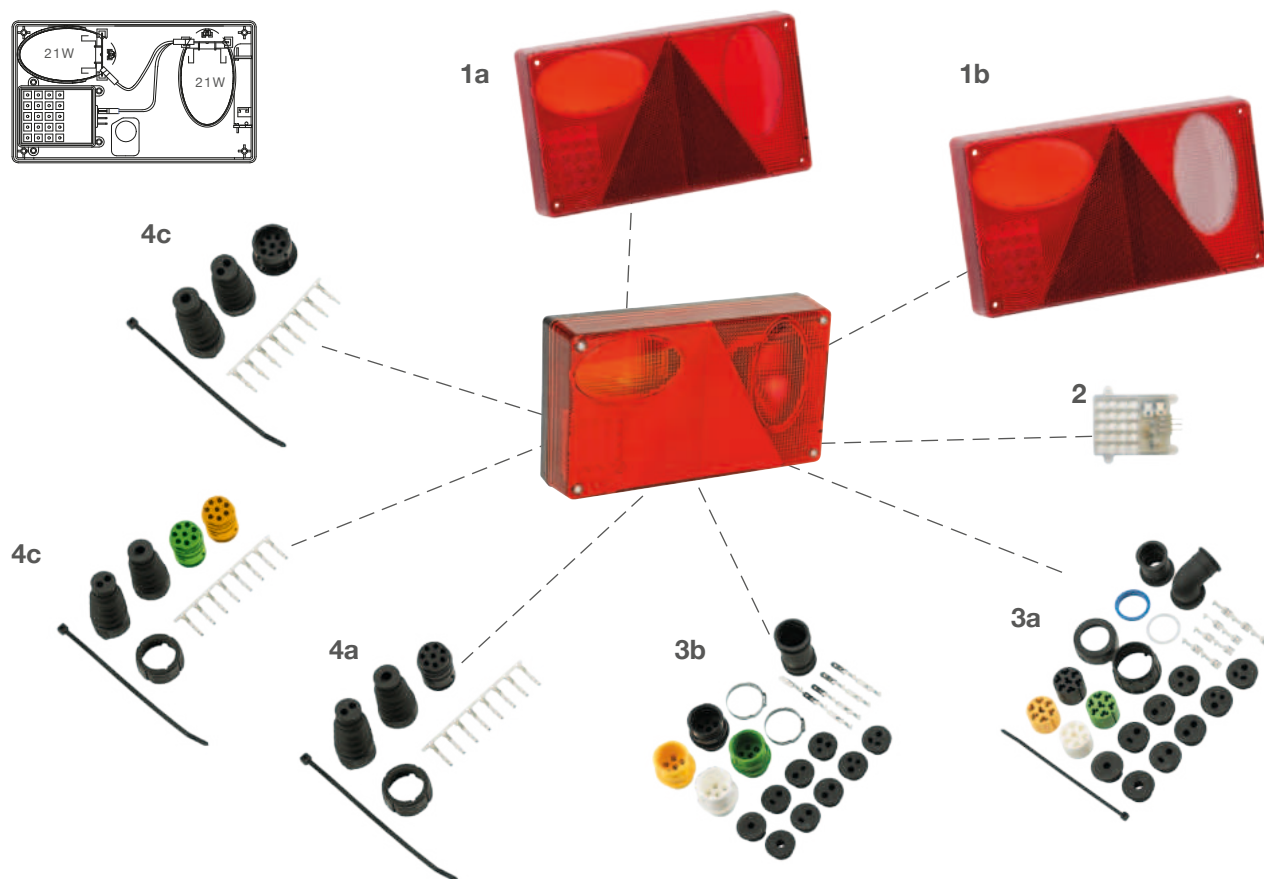
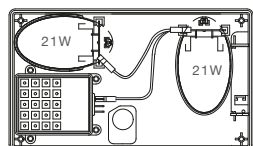

1 Lichtscheibe | lens

- (a) links mit left with 18-8457-131
- rechts mit right with 18-8458-051
- (b) links mit für left with for 18-8457-051
- rechts mit right with 18-8458-131

2 LED Einsätze | LED inserts

- 12-1527-004

3 ASS1 & ASS2 Verbinder | ASS1 & ASS2 connector

- (a) 7 pol. weiblich
7 pin female 13-5626-631
- (b) 7 pol. männlich
7 pin male 13-5625-981

4 Bajonett Verbinder | bayonet connector

- (a) 8 pol. weiblich
8 pin female 13-0828-034
- (b) 8 pol. weiblich
8 pin female 15-0821-524
- (c) 8 pol. männlich
8 pin male 13-0838-054

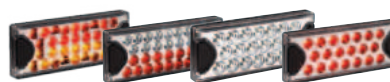

MINILED II

ADR Zone 2 IP 6K9K



Produktinformation
Product information

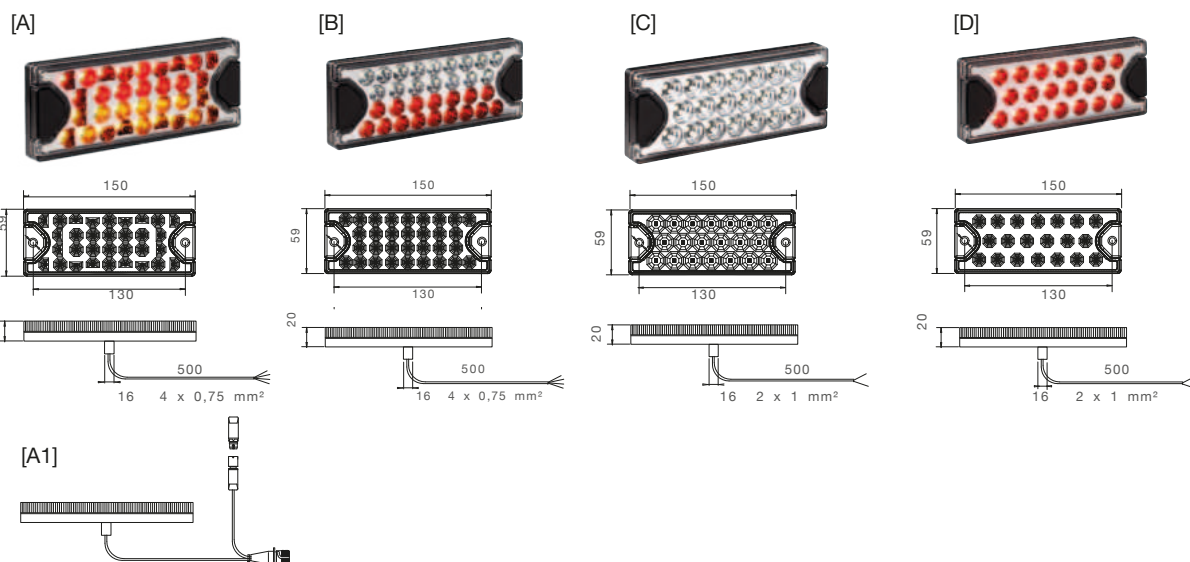

BEST. NR PART NO	Box	←	→	LED	12V 24V	Light icon	FUNKTION	ANSCHLUSS	
							FUNCTION	CONNECTOR	
32-7200-001	1/20	●	●	LED	12V 24V	[B]	⚡ ⚡	offenes Ende open end 0,50 m	
32-7207-001	1/50	●	●	LED	12V 24V	[B]	⚡ ⚡	3 pol. ASS3 3 pin ASS3 ♀ ♂	
33-7200-001	1/20	●	●	LED	12V 24V	[A]	⬅ ➡	offenes Ende open end 0,50 m	
33-7200-011	1/-	●	●	LED	12V 24V	[A]	⬅ ➡	offenes Ende open end 5,00 m	
33-7207-041	1/-	●		LED	12V 24V	[A1]	⬅ ➡	7 pol. ASS2 7 pin ASS2 ♂	0,50 m
								3 pol. ASS3 3 pin ASS3 ♂	0,25 m
33-7207-051	1/-		●	LED	12V 24V	[A1]	⬅ ➡	7 pol. ASS2 7 pin ASS2 ♂	0,50 m
								3 pol. ASS3 3 pin ASS3 ♂	0,25 m
37-7200-001	1/20	●	●	LED	12V 24V	[D]	⚡	offenes Ende open end 0,50 m	
37-7207-001	1/30	●	●	LED	12V 24V	[D]	⚡	2 pol. ASS3 2 pin ASS3 ♀ ♂	
38-7200-001	1/20	●	●	LED	12V 24V	[C]	⚡	offenes Ende open end 0,50 m	
38-7207-001	1/20	●	●	LED	12V 24V	[C]	⚡	2 pol. ASS3 2 pin ASS3 ♀ ♂	



MINILED II

ZUBEHÖR / ACCESSORIES

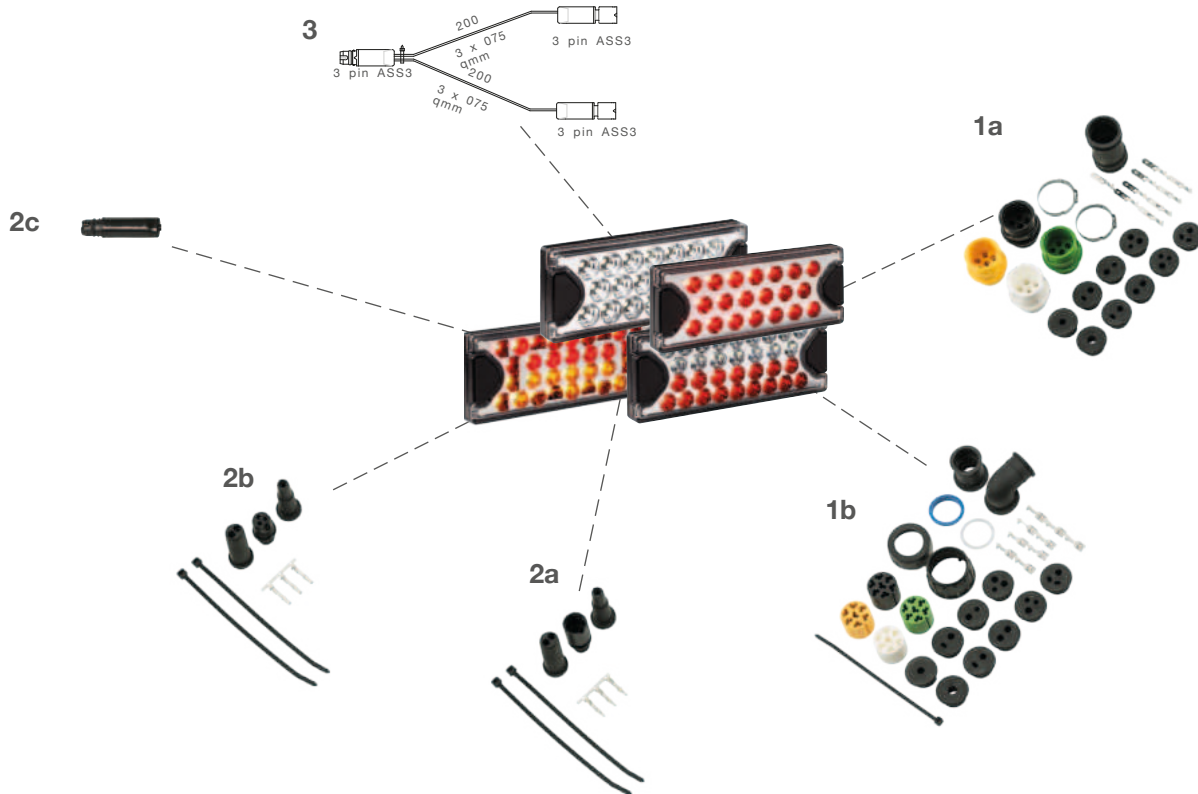

- 1** **ASS1 & ASS2 Verbinder |**
ASS1 & ASS2 connector
- (a) 7 pol. männlich
7 pin male 13-5625-981
 - (b) 7 pol. weiblich
7 pin female 13-5626-631
- 2** **ASS3 Verbinder | ASS3 connector**
- (a) 3 pol. männlich
3 pin male 13-0332-281
 - (b) 3 pol. weiblich
3 pin female 13-0322-281
 - (c) 3 pol. Verschlusskappe
3 pin connection 13-0320-004
- 3** **Y-Kabel 3 pol. ASS3 | Y-cable 3 pin ASS3**
..... 65-6502-014



LINEPOINT II

ADR Zone 2 IP 6K9K



Produktinformation
Product information

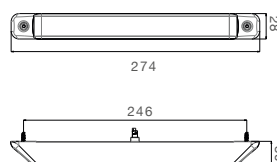
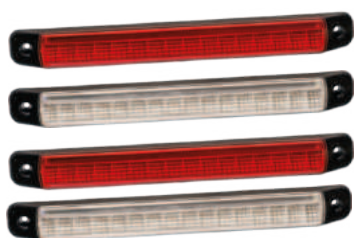

BEST. NR		←	→	LED	12V		FUNKTION	ANSCHLUSS
PART NO					24V		FUNCTION	CONNECTOR
31-9207-031	-/-	●		LED	12V		↔	2 pol. ASS3 2 pin ASS3 ♀
31-9207-071	-/-	●		LED	12V		↔	2 pol. ASS3 2 pin ASS3 ♀
31-9231-201	1/-	●		LED	12V		↔	offenes Ende open end
31-9207-021	1/40		●	LED	12V		↔	2 pol. ASS3 2 pin ASS3 ♀
31-9207-061	1/50		●	LED	12V		↔	2 pol. ASS3 2 pin ASS3 ♀
31-9231-211	1/-		●	LED	12V		↔	offenes Ende open end
31-9207-011	1/-	●	●	LED	12V		↔	3 pol. ASS3 3 pin ASS3 ♀
31-9231-001	1/-	●	●	LED	12V		↔	offenes Ende open end
31-9207-001	1/-	●	●	LED	12V		↔	3 pol. ASS3 3 pin ASS3 ♀
31-9230-001	1/-	●	●	LED	12V		↔	offenes Ende open end
31-9207-081	1/50	●	●	LED	12V		↔	3 pol. ASS3 3 pin ASS3 ♀
37-9207-001	1/-	●	●	LED	12V		↔	3 pol. ASS3 3 pin ASS3 ♀
37-9230-001	1/-	●	●	LED	12V		↔	offenes Ende open end
38-9207-001	1/-	●	●	LED	12V		↔	3 pol. ASS3 3 pin ASS3 ♀
38-9230-001	1/-	●	●	LED	12V		↔	offenes Ende open end
38-9231-001	1/-	●	●	LED	12V		↔	offenes Ende open end
38-9237-001	1/-	●	●	LED	12V		↔	3 pol. ASS3 3 pin ASS3 ♀
38-9207-021	-/-	●	●	LED	12V		↔	3 pol. ASS3 3 pin ASS3 ♀



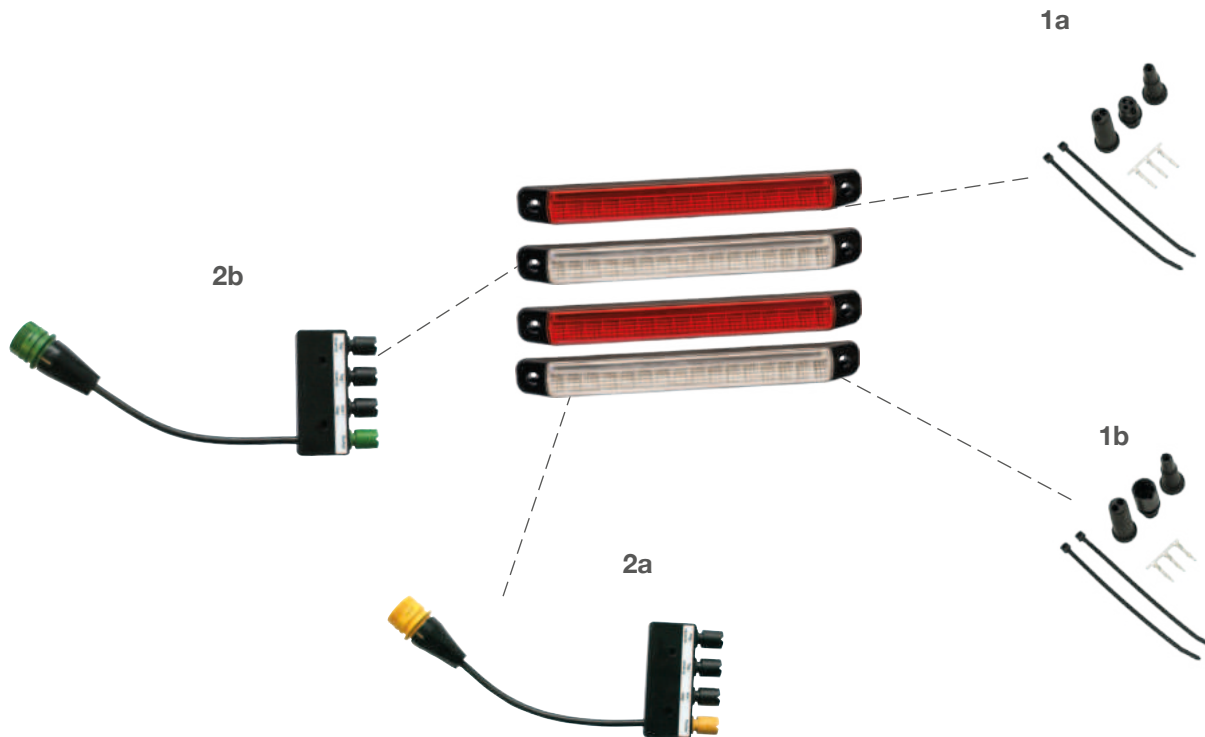

LINEPOINT II

ZUBEHÖR / ACCESSORIES



1 ASS3 Verbinder | ASS3 connector

- (a) 3 pol. weiblich
3 pin female 13-0322-281 
- (b) 3 pol. männlich
3 pin male 13-0332-281 

2 ASS3 Verteiler | ASS3 junction box

- (a) links
left 76-9027-001 
- (b) rechts
right 76-9028-001 



LINEPOINT I

ADR Zone 2 IP 6K9K



Produktinformation
Product information

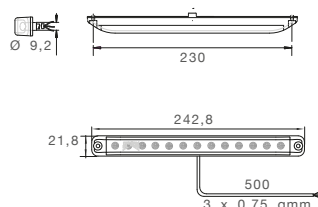

BEST. NR		←	→	LED	12V 24V	FUNKTION	ANSCHLUSS
PART NO						FUNCTION	CONNECTOR
31-8920-001	1/-	●	●	LED	12V 24V		offenes Ende 2 pol. open end 2 pin 0,50 m
31-8927-001	1/50	●	●	LED	12V 24V		2 pol. ASS3 2 pin ASS3 ♀ 0,50 m
31-9207-041	1/50	●	●	LED	12V 24V		3 pol. ASS3 3 pin ASS3 ♀ 0,50 m
31-9207-051	1/50	●	●	LED	12V 24V		2 pol. ASS3 2 pin ASS3 ♀ 0,50 m
31-9220-001	1/-	●	●	LED	12V 24V		offenes Ende 3 pol. open end 3 pin 0,50 m
31-9220-011	1/40	●	●	LED	12V 24V		3 pol. AMP 3 pin AMP ♂ 0,15 m
31-9221-001	1/-	●	●	LED	12V 24V		offenes Ende 2 pol. open end 2 pin 0,50 m
31-9221-011	1/40	●	●	LED	12V 24V		2 pol. Superseal 2 pin Superseal ♂ 0,15 m
37-9207-011	1/50	●	●	LED	12V 24V		3 pol. ASS3 3 pin ASS3 ♀ 0,50 m
37-9220-001	1/-	●	●	LED	12V 24V		offenes Ende 2 pol. open end 2 pin 0,50 m
37-9220-011	1/40	●	●	LED	12V 24V		2 pol. Superseal 2 pin Superseal ♂ 0,15 m
38-9207-011	1/-	●	●	LED	12V 24V		2 pol. ASS3 2 pin ASS3 ♀ 0,50 m
38-9220-001	1/-	●	●	LED	12V 24V		offenes Ende 2 pol. open end 2 pin 0,50 m
38-9220-011	1/40	●	●	LED	12V 24V		2 pol. Superseal 2 pin Superseal ♂ 0,15 m
33-8914-001	1/-	●	●	LED	12V 24V		offenes Ende open end 0,50 m
33-8914-011	1/-	●	●	LED	12V 24V		offenes Ende open end 5,00 m



LINEPOINT I

ZUBEHÖR / ACCESSORIES

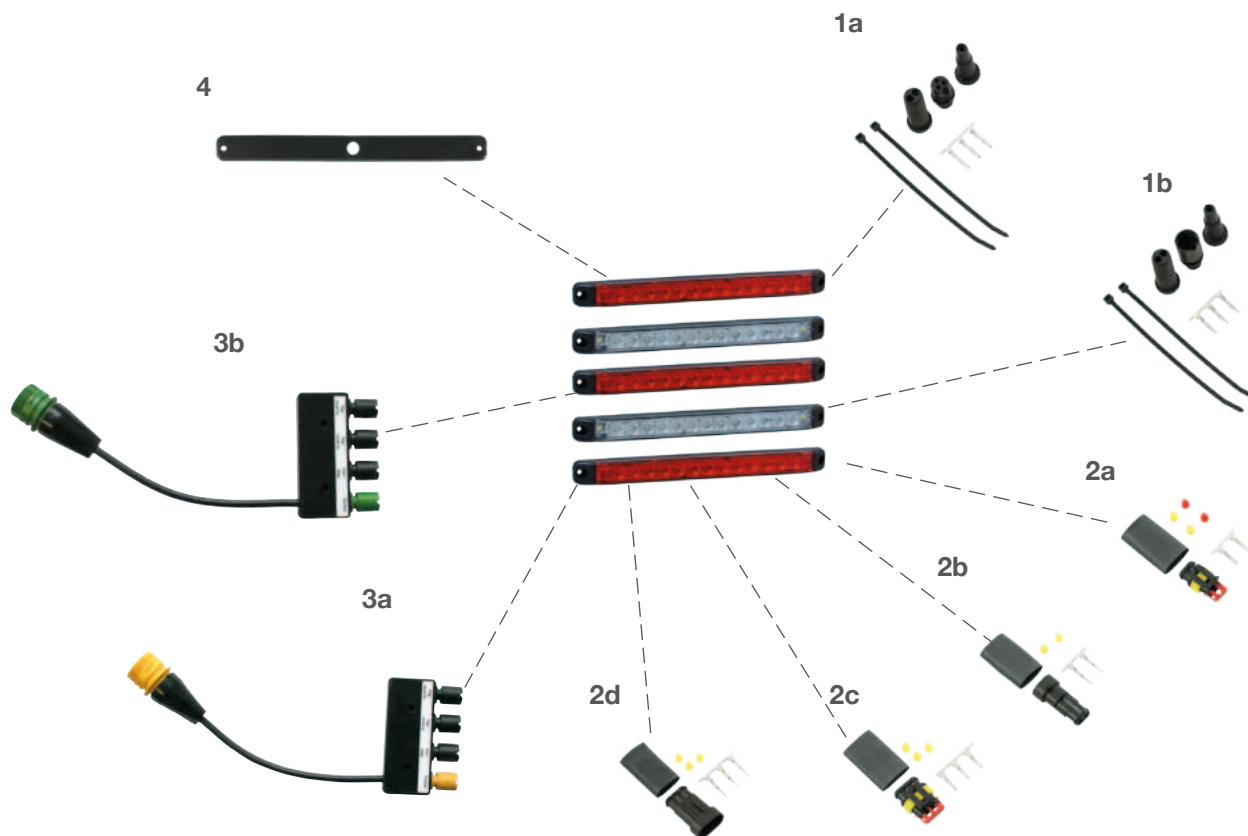

1 ASS3 Verbinder | ASS3 connector

- (a) 3 pol. weiblich
3 pin female 13-0322-281 
- (b) 3 pol. männlich
3 pin male 13-0332-281 

2 Superseal Verbinder | Superseal connector

- (a) 2 pol. weiblich
2 pin female 15-7002-044
- (b) 2 pol. männlich
2 pin male 15-7002-054
- (c) 3 pol. weiblich
3 pin female 15-7002-064
- (d) 3 pol. männlich
3 pin male 15-7002-074

3 ASS3 Verteiler | ASS3 junction box

- (a) links
left 76-9027-001 
- (b) rechts
right 76-9028-001 

4 Gummiunterlage | rubber pad

- 15-5111-404 



POSIPOINT IV

ADR Zone 2 IP 6K9K



Produktinformation
Product information

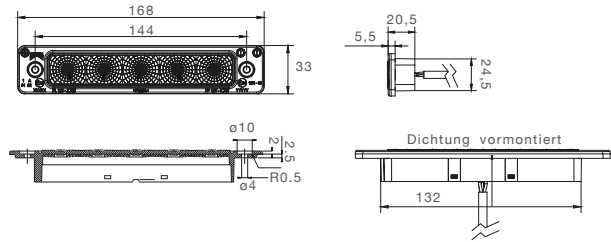

BEST. NR		←	→	LED	V	FUNKTION	ANSCHLUSS
PART NO	☐	●	●	LED	V	FUNCTION	CONNECTOR
32-7344-024	1/-	●	●	LED	12V	↔ ⊕ ⊖	Lear 16644.559.699 ♂ ⊕ ⊖ 0,20 m ↗
33-7344-014	1/-	●	●	LED	12/24V	↔ ⊕ ⊖	offenes Ende open end 0,50 m ↗
33-7344-044	1/-	●	●	LED	12V	⊕ ⊖ ↔ ⊕ ⊖	4 pol. Deutsch 4 pin Deutsch ♂ ⊕ ⊖ ⊕ ⊖
33-7344-024	1/-	●	●	LED	12V	⊕ ⊖ ↔ ⊕ ⊖	5 pol. Bajonett 5 pin Bayonet ♂ ⊕ ⊖ ⊕ ⊖
32-7344-014	1/-	●	●	LED	12/24V	↔ ⊕ ⊖ ↔	offenes Ende open end 0,50 m ↗



POSIPOINT IV

ZUBEHÖR / ACCESSORIES

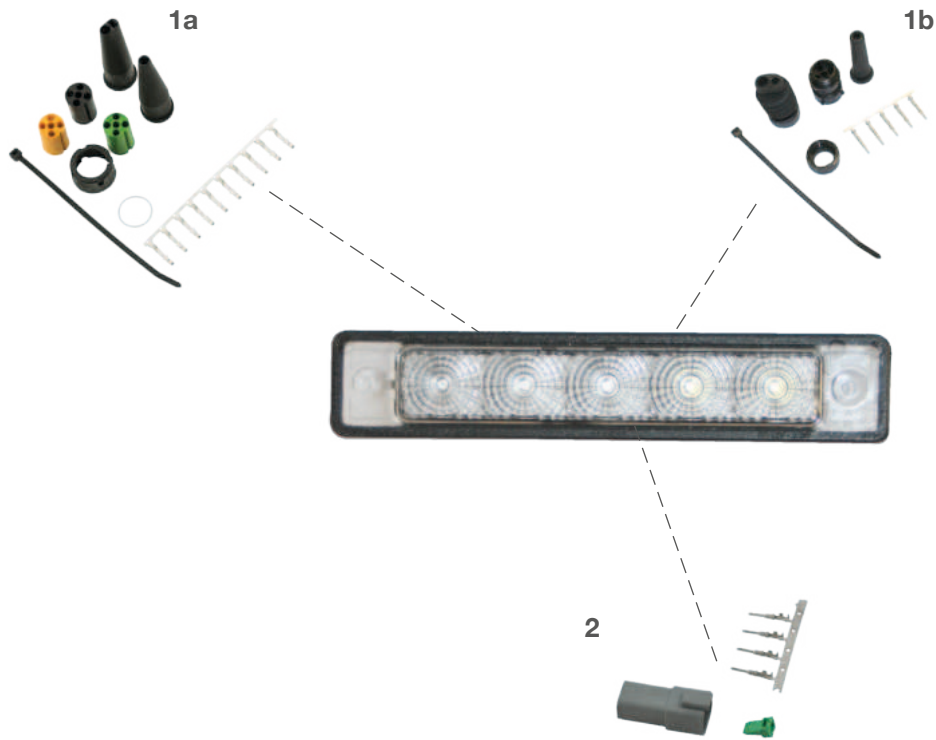

1 Bajonett Verbinder | bayonet connector

- (a) 5 pol. weiblich
5 pin female 13-0521-104
- (b) 5 pol. männlich
5 pin male 13-0536-044

2 Deutsch Verbinder | Deutsch connector

- 4 pol. männlich
4 pin male 15-7002-145



BRASPOINT 98

ADR Zone 2 IP 6K9K



Produktinformation
Product information

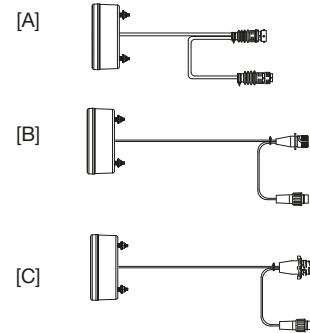
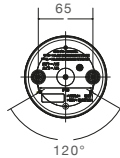
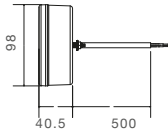

Blinklicht Direction indicator	Rücklicht Tail light	Bremslicht Stop light	

BEST. NR		←	→	💡	⚡		ZUSATZ	ANSCHLUSS
PART NO				LED	12V 24V		ADD ON	CONNECTOR
33-9200-001	1/-	●	●	LED	12V 24V			offenes Ende open end 0,50 m
33-9200-011	1/-	●	●	LED	12V 24V			offenes Ende open end 7,00 m
33-9200-021	1/-	●	●	LED	12V 24V			offenes Ende open end 2,00 m
33-9200-501	1/-	●	●	LED	12V 24V			5 pol. Bajonett 5 pin Bayonet 0,50 m
33-9200-511	1/-	●	●	LED	12V 24V		[A]	8 pol. Bajonett 8 pin Bayonet 0,50 m
		●	●				8 pol. Bajonett 8 pin Bayonet 0,25 m	
33-9207-051	1/-	●	●	LED	12V 24V		[B]	7 pol. ASS2 7 pin ASS2 0,50 m
		●	●				7 pol. ASS2 7 pin ASS2 0,20 m	
33-9207-081	1/-	●	●	LED	12V 24V		[C]	7 pol. AMP 7 pin AMP 0,50 m
		●	●				7 pol. ASS2 7 pin ASS2 0,20 m	
33-9280-001	1/25	●	●	LED	12V 24V			4 pol. AMP 4 pin AMP 0,50 m



BRASPOINT 98

ADR Zone 2 IP 6K9K



Produktinformation
Product information

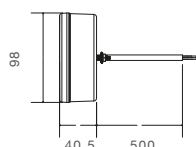

	Rücklicht Tail light		Nebelschlusslicht Fog light
	Rückfahrlicht Reverse light		Rückstrahler rot Reflector red

BEST. NR	Box	←	→	LED	V		ZUSATZ	ANSCHLUSS
PART NO							ADD ON	CONNECTOR
33-8100-001	1/-	●	●	LED	12V 24V			offenes Ende open end 0,50 m
33-8100-101	1/-	●	●	LED	12V 24V			offenes Ende open end 0,50 m
33-8100-501	1/-	●	●	LED	12V 24V			8 pol. Bajonett 8 pin Bayonet 0,50 m
33-8100-601	1/-	●	●	LED	12V 24V			8 pol. Bajonett 8 pin Bayonet 0,50 m
33-8107-041	1/-	●	●	LED	12V 24V			7 pol. ASS2 7 pin ASS2 0,50 m
33-8107-051	1/-	●	●	LED	12V 24V			7 pol. ASS2 7 pin ASS2 0,50 m
33-8180-001	1/10	●	●	LED	12V 24V			4 pol. AMP 4 pin AMP 0,50 m



BRASPOINT 98

ZUBEHÖR / ACCESSORIES

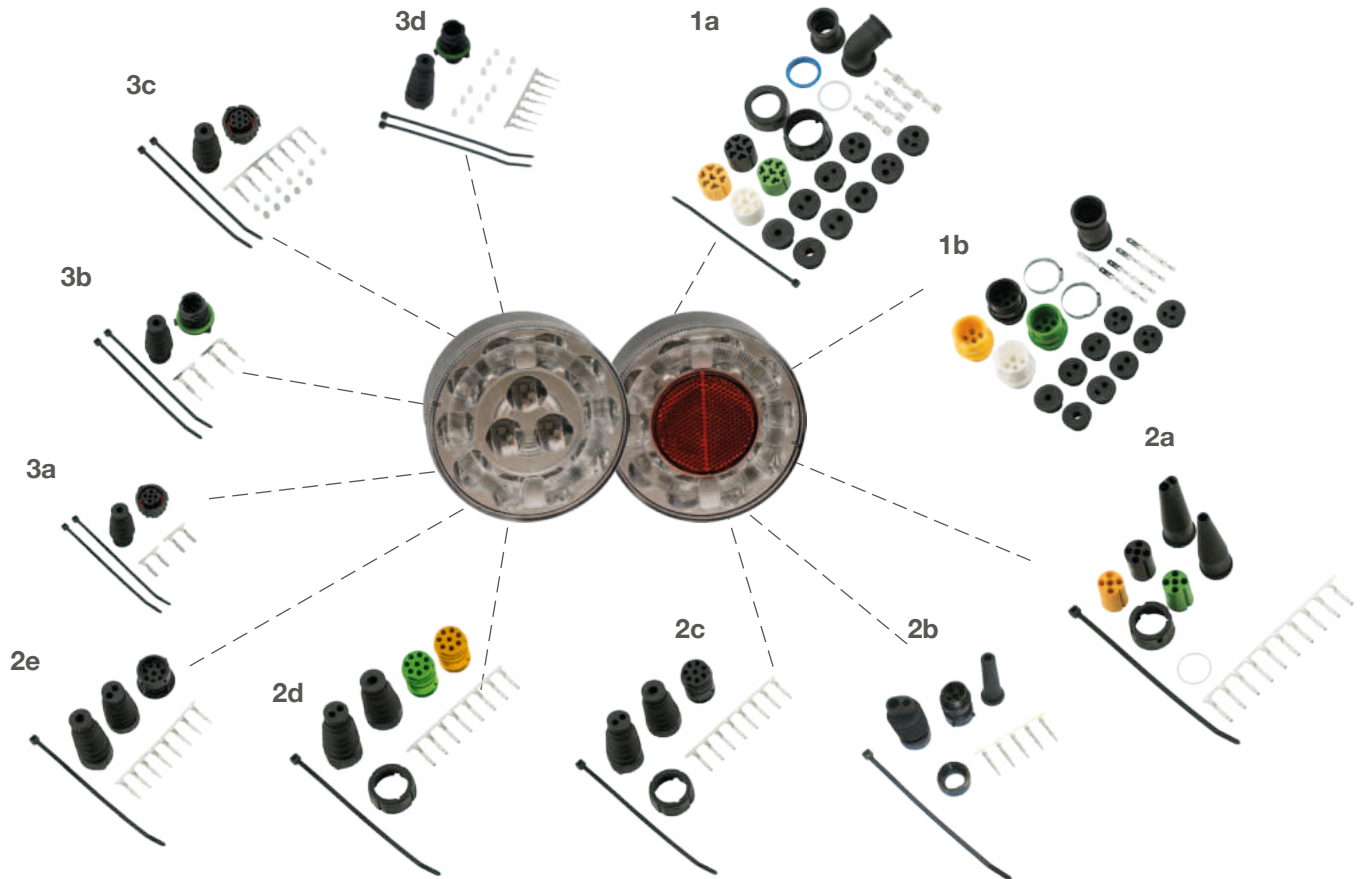

1 ASS1 & ASS2 Verbinder | ASS1 & ASS2 connector

- (a) 7 pol. weiblich
7 pin female 13-5626-631
- (b) 7 pol. männlich
7 pin male 13-5625-981

2 Bajonett Verbinder | bayonet connector

- (a) 5 pol. weiblich
5 pin female 13-0521-104
- (b) 5 pol. männlich
5 pin male 13-0536-044
- (c) 8 pol. weiblich
8 pin female 13-0828-034
- (d) 8 pol. weiblich
8 pin female 15-0821-524
- (e) 8 pol. männlich
8 pin male 13-0838-054

3 AMP Verbinder | AMP connector

- (a) 4 pol. weiblich
4 pin female 15-7002-004
- (b) 4 pol. männlich
4 pin male 15-7002-014
- (c) 7 pol. weiblich
7 pin female 15-7002-024
- (d) 7 pol. männlich
7 pin male 15-7002-034

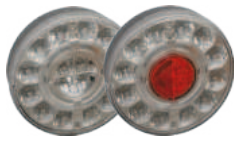

BRASPOINT 140

ADR Zone 2 IP 6K9K



Produktinformation
Product information

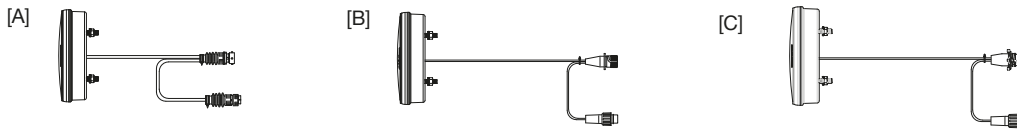
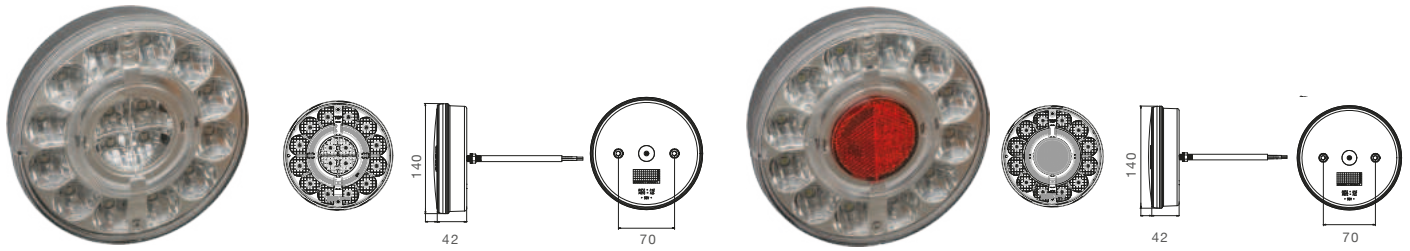

BEST. NR		←	→	LED	12V		FUNKTION	ANSCHLUSS
PART NO							FUNCTION	CONNECTOR
33-9200-201	1/-	●	●	LED	12V 24V			offenes Ende open end 0,50 m
33-9200-701	1/-	●	●	LED	12V 24V			5 pol. Bajonett 5 pin Bayonet ♂ 0,50 m
33-9200-711	1/-	●	●	LED	12V 24V		[A]	8 pol. Bajonett 8 pin Bayonet ♂ 0,50 m
		●	●					8 pol. Bajonett 8 pin Bayonet ♀ 0,25 m
33-9207-061	1/12	●	●	LED	12V 24V		[B]	7 pol. ASS2 7 pin ASS2 ♂ 0,50 m
		●	●					7 pol. ASS2 7 pin ASS2 ♀ 0,20 m
33-9207-091	1/12	●	●	LED	12V 24V		[C]	7 pol. AMP 7 pin AMP ♂ 0,50 m
		●	●					7 pol. ASS2 7 pin ASS2 ♀ 0,20 m
33-9200-221	1/-	●	●	LED	12V 24V			offenes Ende open end 1,50 m
33-9200-531	1/-	●	●	LED	12V 24V		[B]	7 pol. ASS2 7 pin ASS2 ♂ 1,50 m
		●	●					7 pol. ASS2 7 pin ASS2 ♀ 0,30 m
33-8100-201	1/-	●	●	LED	12V 24V			offenes Ende open end 0,50 m
33-8100-701	1/-	●	●	LED	12V 24V			8 pol. Bajonett 8 pin Bayonet ♂ 0,50 m
33-8107-031	1/-	●	●	LED	12V 24V			7 pol. ASS2 7 pin ASS2 ♂ 0,50 m
33-9200-211	1/-	●	●	LED	12V 24V			offenes Ende open end 1,50 m
33-9200-521	1/-	●	●	LED	12V 24V			7 pol. ASS2 7 pin ASS2 ♂ 1,50 m



BRASPOINT 140

ZUBEHÖR / ACCESSORIES

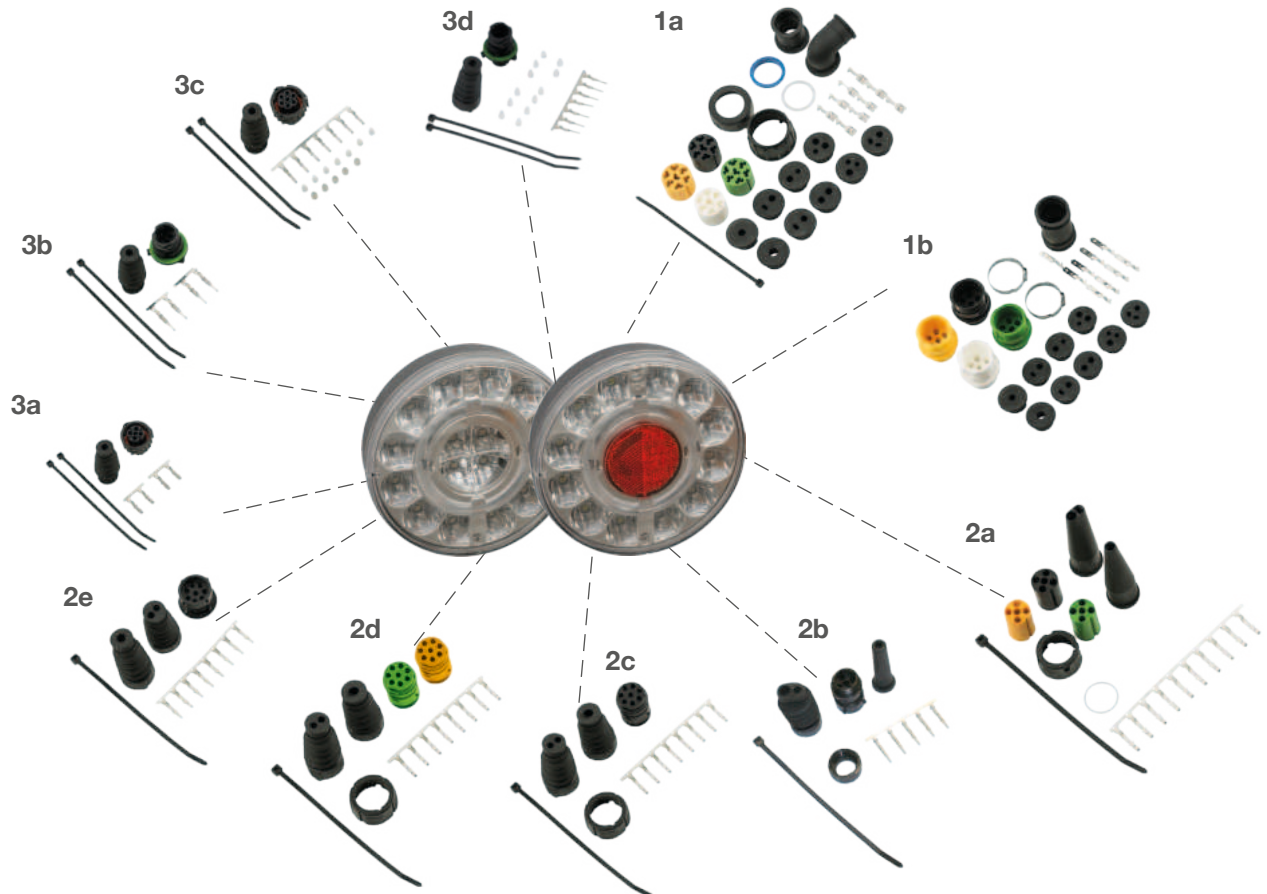

1 ASS1 & ASS2 Verbinder | ASS1 & ASS2 connector

- (a) 7 pol. weiblich
7 pin female 13-5626-631
- (b) 7 pol. männlich
7 pin male 13-5625-981

2 Bajonett Verbinder | bayonet connector

- (a) 5 pol. weiblich
5 pin female 13-0521-104
- (b) 5 pol. männlich
5 pin male 13-0536-044
- (c) 8 pol. weiblich
8 pin female 13-0828-034
- (d) 8 pol. weiblich
8 pin female 15-0821-524
- (e) 8 pol. männlich
8 pin male 13-0838-054

3 AMP Verbinder | AMP connector

- (a) 4 pol. weiblich
4 pin female 15-7002-004
- (b) 4 pol. männlich
4 pin male 15-7002-014
- (c) 7 pol. weiblich
7 pin female 15-7002-024
- (d) 7 pol. männlich
7 pin male 15-7002-034



ROUNDPOINT II

ADR Zone 2 IP 6K9K



Produktinformation
Product information

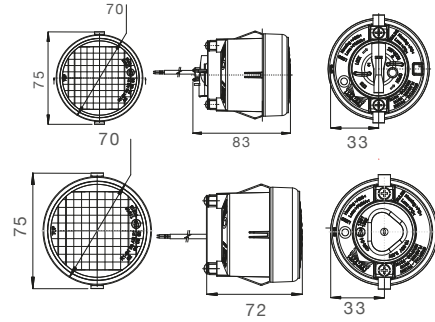

BEST. NR PART NO		←	→				ZUSATZ	ANSCHLUSS
							ADD ON	CONNECTOR
31-7600-001	1/-	●	●		12V			offenes Ende open end 1,80 m
32-7600-001	1/-	●	●		12V			offenes Ende open end 1,80 m
37-7600-001	1/-	●	●		12V			offenes Ende open end 1,80 m
38-7600-001	1/-	●	●		12V			offenes Ende open end 1,80 m



ROUNDPOINT II LED

ZUBEHÖR / ACCESSORIES

ADR Zone 2 IP 6K9K



Produktinformation
Product information

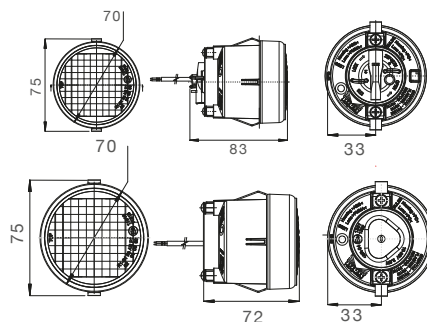

BEST. NR		←	→	LED	12V 24V	⚡	ZUSATZ ADD ON	ANSCHLUSS CONNECTOR
31-7600-701	1/96	●	●	LED	12V 24V			offenes Ende open end 1,80 m
32-7600-701	1/96	●	●	LED	12V 24V			offenes Ende open end 1,80 m
37-7600-701	1/96	●	●	LED	12V 24V			offenes Ende open end 1,80 m
38-7600-701	1/96	●	●	LED	12V 24V			offenes Ende open end 1,80 m

ZUBEHÖR / ACCESSORIES

1 Lichtscheibe inklusive Gehäuse | lens including housing

- (a) 21-7600-001
- (b) 22-7600-001
- (c) 27-7600-001
- (d) 28-7600-001

Glühlampe | bulb

- 12V 21W, BA15s 16-6121-017
- 12V 21W / 5W 16-6122-017





3 CHAMBER LAMP II LED

ADR
Zone 2

IP 54

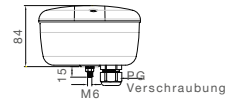
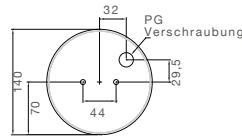
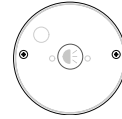
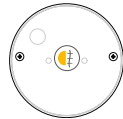
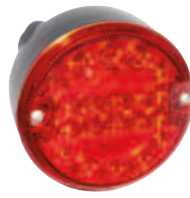
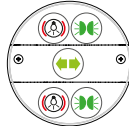
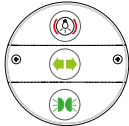

BEST. NR	PART NO		←	→			FUNKTION	ANSCHLUSS
							FUNCTION	CONNECTOR
22-7000-701	1/10	●	●	LED	12V 24V			PG 11 Verschraubung cable glands 11
23-8400-751	1/10	●	●	LED	12V 24V		2x 2x	PG 11 Verschraubung cable glands 11
23-8400-761	1/-	●	●	LED	12V 24V		2x 2x	PG 16 Verschraubung cable glands 16
23-8400-771	1/-	●	●	LED	12V 24V		2x 2x	8 pol. Bajonett 8 pin Bayonet
23-8400-781	1/-	●	●	LED	12V 24V		2x 2x	5 pol. Bajonett 5 pin Bayonet
23-8400-801	1/10	●	●	LED	12V 24V			PG 11 Verschraubung cable glands 11
23-8400-811	1/10	●	●	LED	12V 24V			PG16 Verschraubung cable glands 16
23-8400-821	1/20	●	●	LED	12V 24V			8 pol. Bajonett 8 pin Bayonet
27-8100-721	1/-	●	●	LED	12V 24V			8 pol. Bajonett 8 pin Bayonet
27-8400-701	1/10	●	●	LED	12V 24V			PG 11 Verschraubung cable glands 11
28-8100-731	1/20	●	●	LED	12V 24V			8 pol. Bajonett 8 pin Bayonet
28-8400-701	1/-	●	●	LED	12V 24V			PG 11 Verschraubung cable glands 11
32-7000-701	1/10	●	●	LED	12V 24V			7 pol. ASS2 7 pin ASS2
33-8400-011	1/-		●	LED	12V 24V			offnes Ende open end
33-8402-031	1/10		●	LED	12V 24V		2x 2x	offnes Ende open end
33-8403-031	1/10	●		LED	12V 24V		2x 2x	offnes Ende open end



3 CHAMBER LAMP II LED

ADR
Zone 2

IP 54

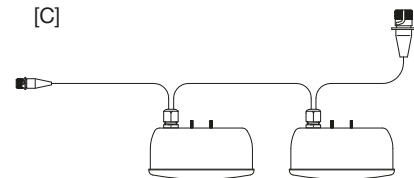
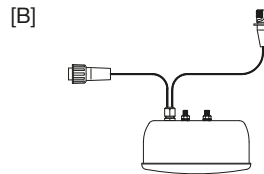
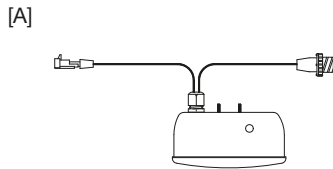

BEST. NR PART NO		←	→				FUNKTION	ANSCHLUSS				
							FUNCTION	CONNECTOR				
33-8403-041	1/-	●		LED	12V 24V					offnes Ende open end	0,50 m	
33-8405-081	1/-	●		LED	12V 24V					7 pol. ASS2 7 pin ASS2	0,50 m	
33-8405-091	1/-	●		LED	12V 24V					7 pol. ASS2 7 pin ASS2	0,50 m	
33-8405-101	1/20	●		LED	12V 24V					7 pol. AMP 7 pin AMP	0,90 m	
										2 pol. Superseal 2 pin Superseal	1,00 m	
33-8406-081	1/10		●	LED	12V 24V					7 pol. ASS2 7 pin ASS2	0,50 m	
33-8406-091	1/-		●	LED	12V 24V					7 pol. ASS2 7 pin ASS2	0,50 m	
33-8406-101	1/20		●	LED	12V 24V		[A]			7 pol. AMP 7 pin AMP	0,90 m	
										2 pol. Superseal 2 pin Superseal	1,00 m	
33-8407-014	1/20	●	●	LED	12V 24V		[B]			7 pol. ASS2 7 pin ASS2	0,15 m	
										7 pol. ASS2 7 pin ASS2	0,15 m	
37-8400-001	1/10	●	●	LED	12V 24V					2 pol. Superseal 2 pin Superseal	0,55 m	
37-8407-001	1/-	●	●	LED	12V 24V					2 pol. ASS2 2 pin ASS2	1,50 m	
38-8107-061	1/-	●	●	LED	12V 24V					7 pol. ASS2 7 pin ASS2	0,15 m	
38-8407-001	1/-	●	●	LED	12V 24V					2 pol. ASS2 2 pin ASS2	1,50 m	
39-7000-001	1/-	●	●	LED	12V 24V					3 pol. AMP 3 pin AMP	0,58 m	
39-7007-001	1/10	●	●	LED	12V 24V					7 pol. ASS2 7 pin ASS2	0,15 m	
87-3079-001	1/-	●		LED	12V 24V		[C]			7 pol. AMP 7 pin AMP	0,90 m	
										2 pol. Superseal 2 pin Superseal	1,00 m	
87-3080-001	1/-		●	LED	12V 24V		[C]			7 pol. AMP 7 pin AMP	0,90 m	
										2 pol. Superseal 2 pin Superseal	1,00 m	



3 CHAMBER LAMP II LED

ZUBEHÖR / ACCESSORIES

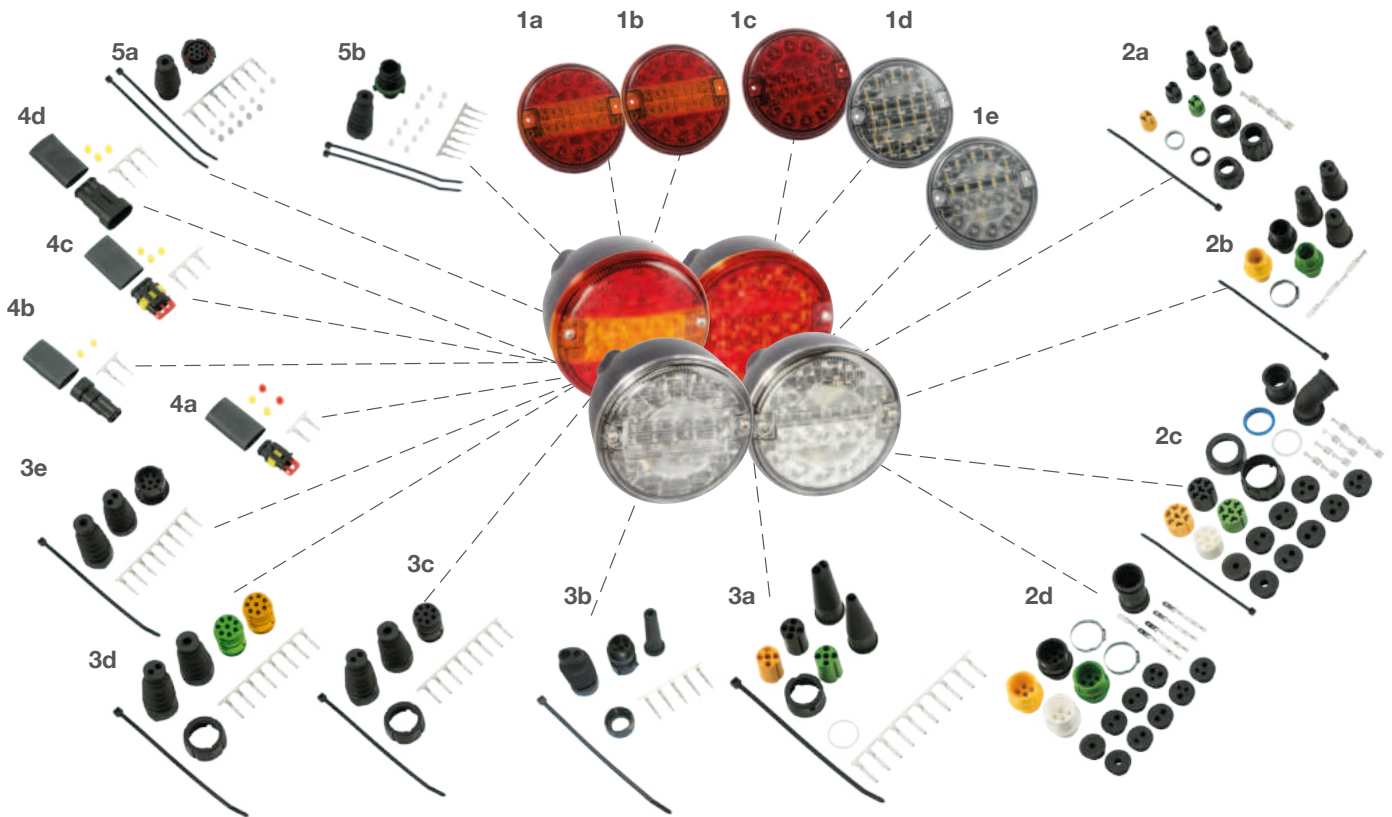

- 1 Lichtscheibe | lens**
- (a) 3 Kammerleuchte Doppelfunktion
3 Chamber double function
..... 18-8384-501
 - (b) 3 Kammerleuchte Einfunktion
3 chamber single function
..... 18-8384-551
 - (c) mit
with 18-8784-501
 - (d) mit
with 18-8884-501
 - (e) mit
with 22-7000-001

- 2 ASS1 & ASS2 Verbinder | ASS1 & ASS2 connector**
- (a) 2 pol. weiblich
2 pin female 13-5626-401
 - (b) 2 pol. männlich
2 pin male 13-5625-991
 - (c) 7 pol. weiblich
7 pin female 13-5626-631
 - (d) 7 pol. männlich
7 pin male 13-5625-981

- 3 Bajonett Verbinder | bayonet connector**
- (a) 5 pol. weiblich
5 pin female 13-0521-104

- (b) 5 pol. männlich
5 pin male 13-0536-044
- (c) 8 pol. weiblich
8 pin female 13-0828-034
- (d) 8 pol. weiblich
8 pin female 15-0821-524
- (e) 8 pol. männlich
8 pin male 13-0838-054

- 4 Superseal Verbinder | Superseal connector**
- (a) 2 pol. weiblich
2 pin female 15-7002-044
 - (b) 2 pol. männlich
2 pin male 15-7002-054
 - (c) 3 pol. weiblich
3 pin female 15-7002-064
 - (d) 3 pol. männlich
3 pin male 15-7002-074

- 5 AMP Verbinder | AMP connector**
- (a) 7 pol. weiblich
7 pin female 15-7002-024
 - (b) 7 pol. männlich
7 pin male 15-7002-034



3 CHAMBER LAMP I LED

ADR
Zone 2

IP 54

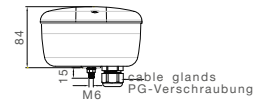
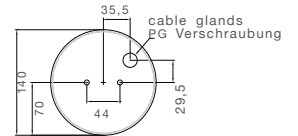
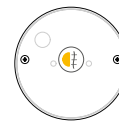
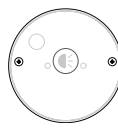
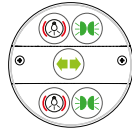
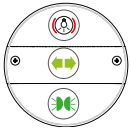

BEST. NR		←	→	LED	24V		FUNKTION	ANSCHLUSS
PART NO							FUNCTION	CONNECTOR
23-8400-711	1/-	●	●	LED	24V			PG 16 Verschraubung cable glands 16
23-8400-721	1/10	●	●	LED	24V			PG 11 Verschraubung cable glands 11
23-8500-701	1/-	●	●	LED	24V		2x 2x	8 pol. Bajonett 8 pin Bayonet
23-8500-721	1/10	●	●	LED	24V		2x 2x	PG 11 Verschraubung cable glands 11
27-8100-701	1/10	●	●	LED	24V			PG 9 Verschraubung cable glands 9
28-8100-711	1/10	●	●	LED	24V			PG 9 Verschraubung cable glands 9

ZUBEHÖR / ACCESSORIES

- 1** Bajonett Verbinder | bayonet connector
8 pol. weiblich
8 pin female 13-0828-034





3 CHAMBER LAMP

ADR
Zone 2

IP 54

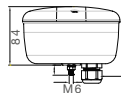

cable glands
PG Verschraubung



cable glands 9
PG11 Verschraubung



cable glands 9
PG11 Verschraubung



cable glands 11
PG11 Verschraubung



cable glands 16
PG16 Verschraubung

BEST. NR	PART NO	←	→	⚡	FUNKTION	ANSCHLUSS	
					FUNCTION	CONNECTOR	
23-8200-011	1/10	●	●	⚡	24V	PG 11 Verschraubung cable glands 11	
23-8200-511	1/10	●	●	⚡	24V	8 pol. Bajonett 8 pin Bayonet	
23-8220-001	1/20	●	●	⚡	24V	18,5 mm Loch 18,5 mm hole	
23-8230-001	1/-	●	●	⚡	24V	PG 16 Verschraubung cable glands 16	
27-8000-021	1/10	●	●	⚡	24V	PG 9 Verschraubung cable glands 9	
27-8001-511	1/-	●	●	⚡	24V	8 pol. Bajonett 8 pin Bayonet	
28-8000-021	1/10	●	●	⚡	24V	PG 9 Verschraubung cable glands 9	
28-8001-521	1/20	●	●	⚡	24V	8 pol. Bajonett 8 pin Bayonet	
33-8205-031	-/-	●		⚡	24V	7 pol. ASS2 7 pin ASS2	
33-8205-081	1/10	●		⚡	24V	7 pol. ASS2 7 pin ASS2	
33-8205-101	1/-	●		⚡	24V	7 pol. AMP 7 pin AMP	
33-8206-031	-/-		●	⚡	24V	7 pol. ASS2 7 pin ASS2	
33-8206-091	1/10		●	⚡	24V	7 pol. ASS2 7 pin ASS2	
33-8206-101	1/-		●	⚡	24V	7 pol. AMP 7 pin AMP	



3 CHAMBER LAMP

ADR
Zone 2

IP 54

[A]

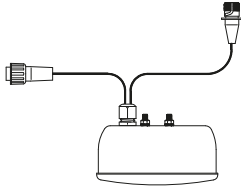

[B]

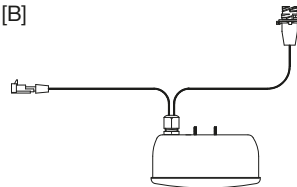

BEST. NR PART NO		←	→				FUNKTION	ANSCHLUSS	
							FUNCTION	CONNECTOR	
37-8000-041	-/-	●	●		24V			2 pol. Superseal 2 pin Superseal ♀	0,25 m
37-8000-061	-/-	●	●		24V			2 pol. Superseal 2 pin Superseal ♀	1,60 m
37-8007-131	1/-	●	●		24V			2 pol. ASS2 2 pin ASS2 ♀	0,25 m
37-8007-161	-/-	●	●		24V			2 pol. ASS2 2 pin ASS2 ♀	1,20 m
37-8007-191	1/-	●	●		24V			2 pol. ASS2 2 pin ASS2 ♀	3,00 m
38-8000-031	-/-	●	●		24V			2 pol. Superseal 2 pin Superseal ♂	0,25 m
38-8000-051	-/-	●	●		24V			2 pol. Superseal 2 pin Superseal ♀	0,25 m
38-8000-061	-/-	●	●		24V			2 pol. Superseal 2 pin Superseal ♀	1,60 m
38-8007-131	1/-	●	●		24V			2 pol. ASS2 2 pin ASS2 ♀	0,25 m
38-8007-141	-/-	●	●		24V			2 pol. ASS2 2 pin ASS2 ♀	3,00 m
38-8007-151	-/-	●	●		24V			2 pol. ASS2 2 pin ASS2 ♀	1,20 m



3 CHAMBER LAMP

ADR Zone 2

IP 54

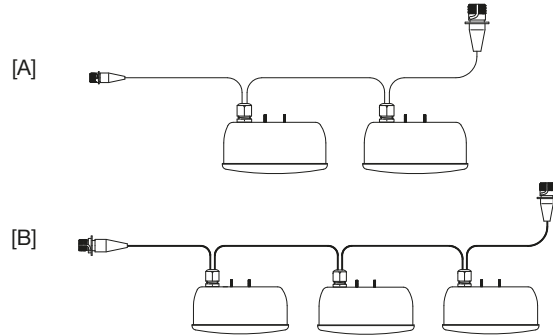
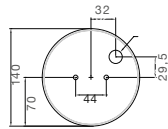
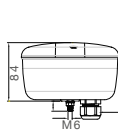

Blinklicht Direction indicator	Rücklicht Tail light	Bremslicht Stop light	

BEST. NR PART NO		←	→				ZUSATZ	ANSCHLUSS
							ADD ON	CONNECTOR
87-3047-021	1/-		●		24V		[A] 7 pol. ASS2 7 pin ASS2 2 pol. ASS2 2 pin ASS2	 0,90 m 1,00 m
87-3048-021	1/-	●			24V		[A] 7 pol. ASS2 7 pin ASS2 2 pol. ASS2 2 pin ASS2	 0,90 m 1,00 m
87-3067-001	-/-		●		24V		[B] 7 pol. ASS2 7 pin ASS2 2 pol. ASS2 2 pin ASS2	 0,90 m 1,00 m
87-3068-001	-/-	●			24V		[B] 7 pol. ASS2 7 pin ASS2 2 pol. ASS2 2 pin ASS2	 0,90 m 1,00 m
87-3081-001	1/-	●			24V		[B] 7 pol. AMP 7 pin AMP 2 pol. Superseal 2 pin Superseal	 0,90 m 1,00 m
87-3082-001	1/-		●		24V		[B] 7 pol. AMP 7 pin AMP 2 pol. Superseal 2 pin Superseal	 0,90 m 1,00 m



3 CHAMBER LAMP

ZUBEHÖR / ACCESSORIES

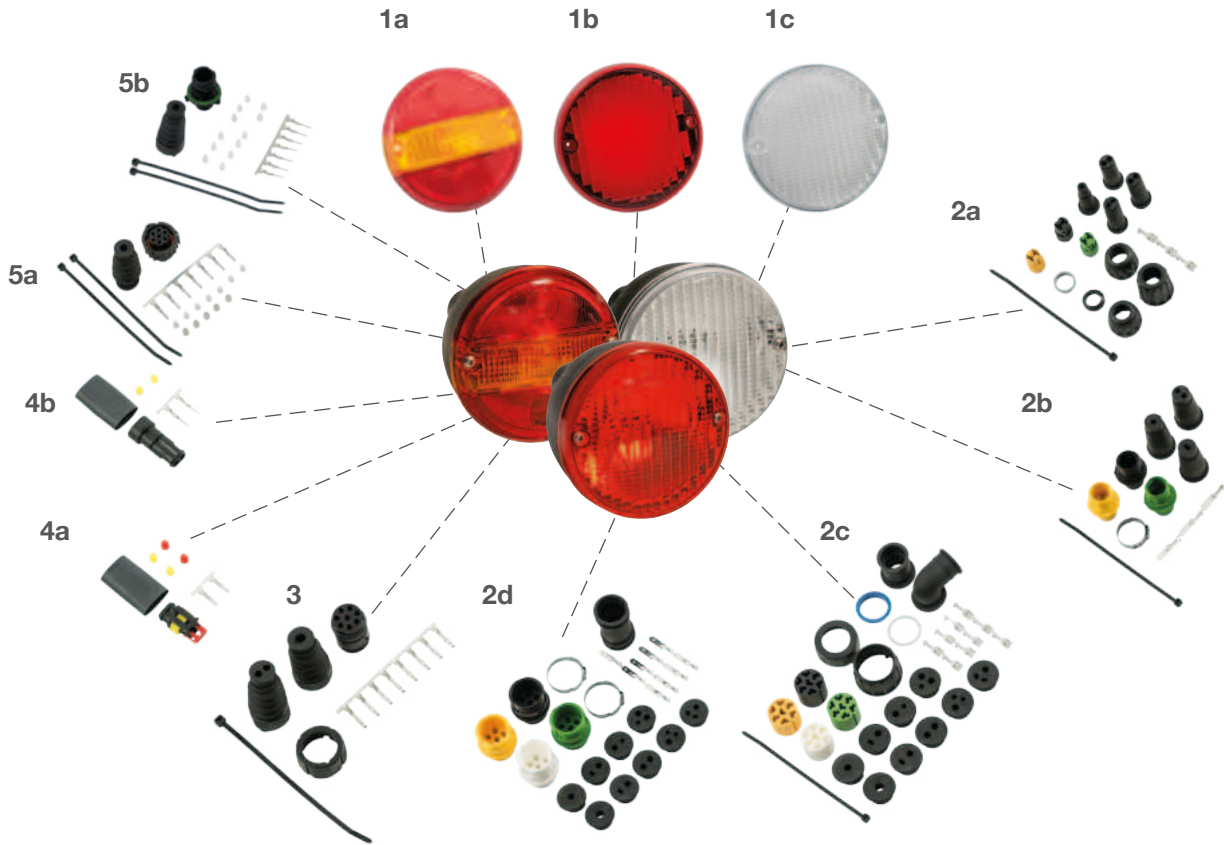

1 Lichtscheibe | lens

- (a) 3 Kammerleuchte
3 chamber lamp..... 18-8382-104
- (b) mit
with 18-8780-104
- (c) mit
with 18-8880-104

2 ASS1 & ASS2 Verbinder | ASS1 & ASS2 connector

- (a) 2 pol. weiblich
2 pin female 13-5626-401
- (b) 2 pol. männlich
2 pin male 13-5625-991
- (c) 7 pol. weiblich
7 pin female 13-5626-631
- (d) 7 pol. männlich
7 pin male 13-5625-981

3 Bajonett Verbinder | bayonet connector

- 8 pol. weiblich
8 pin female 13-0828-034

4 Superseal Verbinder | Superseal connector

- (a) 2 pol. weiblich
2 pin female 15-7002-044
- (b) 2 pol. männlich
2 pin male 15-7002-054

5 AMP Verbinder | AMP connector

- (a) 7 pol. weiblich
7 pin female 15-7002-024
- (b) 7 pol. männlich
7 pin male 15-7002-034

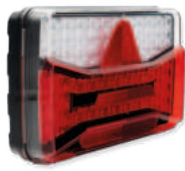

AGRILED I



Produktinformation
Product information

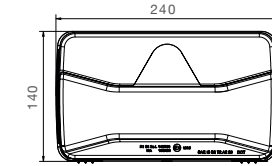
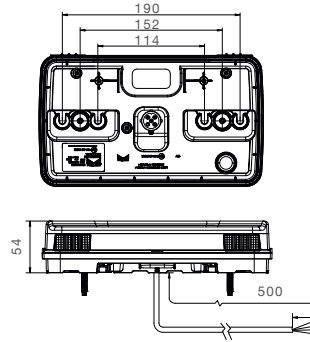
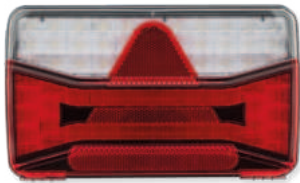

Blinklicht Direction indicator	Rücklicht Tail light	Bremslicht Stop light	Dreieckrückstrahler Triangle reflector

BEST. NR PART NO						ZUSATZ ADD ON	ANSCHLUSS CONNECTOR
23-4124-021	1/-	●	●	LED	12V		5 pol. Bajonett 5 pin Bayonet
23-4124-031	1/-	●	●	LED	12V		5 pol. Bajonett 5 pin Bayonet
23-4124-061	1/-	●	●	LED	12V		5 pol. Bajonett 5 pin Bayonet
23-4124-071	1/-	●	●	LED	12V		5 pol. Bajonett 5 pin Bayonet
33-4114-001	1/-	●	●	LED	12V		5 pol. Bajonett 5 pin Bayonet 1,50 m
33-4124-071	1/-	●	●	LED	12V		offenes Ende open end 0,50 m

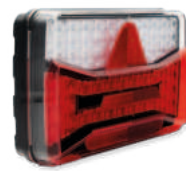

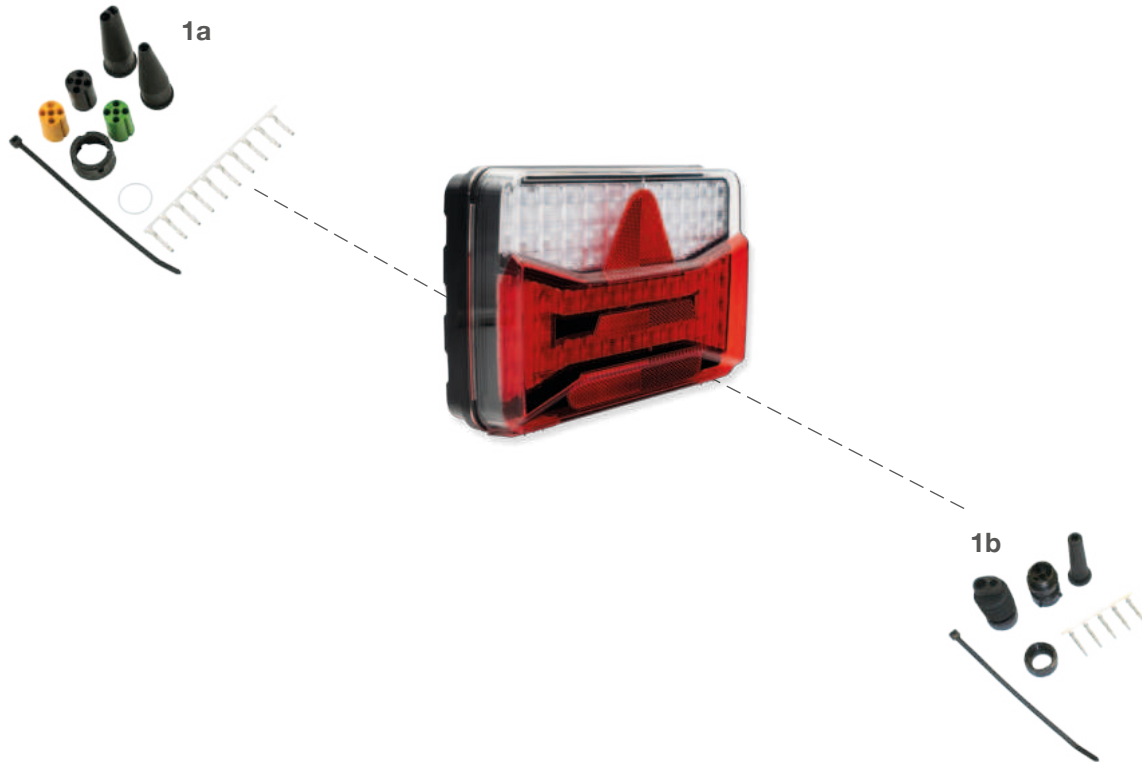

AGRILED I

ZUBEHÖR / ACCESSORIES



1 Bajonett Verbinder | bayonet connector

- (a) 5 pol. weiblich
5 pin female 13-0521-104 
- (b) 5 pol. männlich
5 pin male 13-0536-044 



AGRILED II

ADR Zone 2 IP 6K9K



Produktinformation
Product information

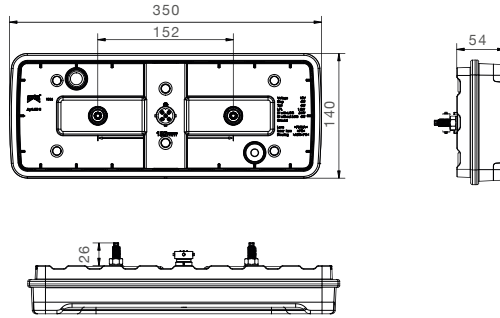
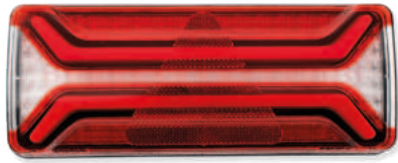

Blinklicht Direction indicator	Rücklicht Tail light	Bremslicht Stop light	Dreieckrückstrahler Triangle reflector

BEST. NR						ZUSATZ	ANSCHLUSS
PART NO						ADD ON	CONNECTOR
23-4124-211	1/-	●	●	LED	12V		5 pol. Bajonett 5 pin Bayonet
23-4124-231	1/-	●	●	LED	12V		5 pol. Bajonett 5 pin Bayonet
33-4124-241	1/-	●		LED	12V		7 pol. ASS2 7 pin ASS2
33-4124-251	1/-	●		LED	12V		7 pol. ASS2 7 pin ASS2
33-4124-271	1/-		●	LED	12V		7 pol. ASS2 7 pin ASS2
33-4124-261	1/-		●	LED	12V		7 pol. ASS2 7 pin ASS2

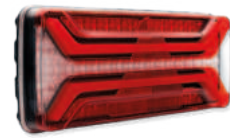

AGRILED II

ZUBEHÖR / ACCESSORIES

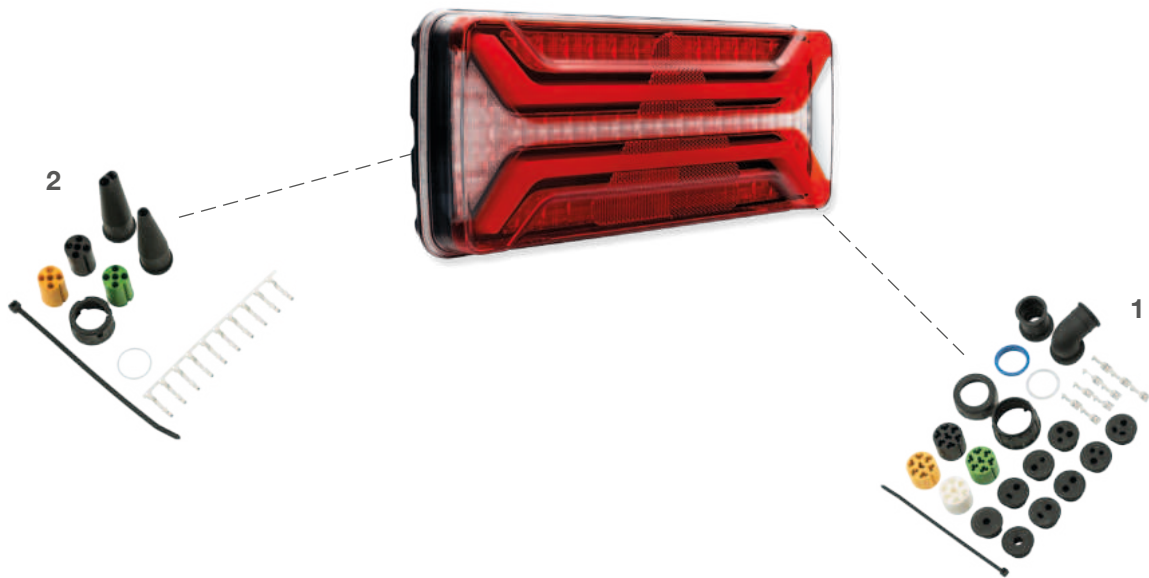

1 **ASS2 Verbinder | ASS2 connector**
7 pol. weiblich
7 pin. female 13-5626-631 

2 **Bajonett Verbinder | bayonet connector**
5 pol. weiblich
5 pin female 13-0521-104 



AGRIPOINT

ADR Zone 2 IP 6K9K



Produktinformation
Product information

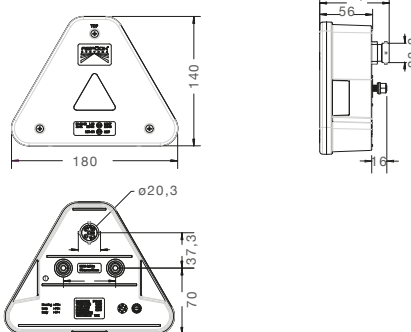

Blinklicht Direction indicator	Rücklicht Tail light	Bremslicht Stop light	Dreieckrückstrahler Triangle reflector

BEST. NR PART NO						ZUSATZ ADD ON	ANSCHLUSS CONNECTOR
23-4004-501	1/20	●	●		12V		5 pol. Bajonett 5 pin Bayonet
23-4004-531	1/20	●	●		12V		5 pol. Bajonett 5 pin Bayonet
23-4004-001	1/20	●	●		12V		offenes Ende open end 0,50 m
23-4004-031	1/20	●	●		12V		offenes Ende open end 0,50 m
23-4000-501	1/20	●	●		12V		5 pol. ASS2 5 pin ASS2
23-4000-531	1/20	●	●		12V		5 pol. ASS2 5 pin ASS2
23-4000-001	1/20	●	●		12V		offenes Ende open end 0,50 m
23-4000-031	1/20	●	●		12V		offenes Ende open end 0,50 m



AGRIPOINT

ZUBEHÖR / ACCESSORIES

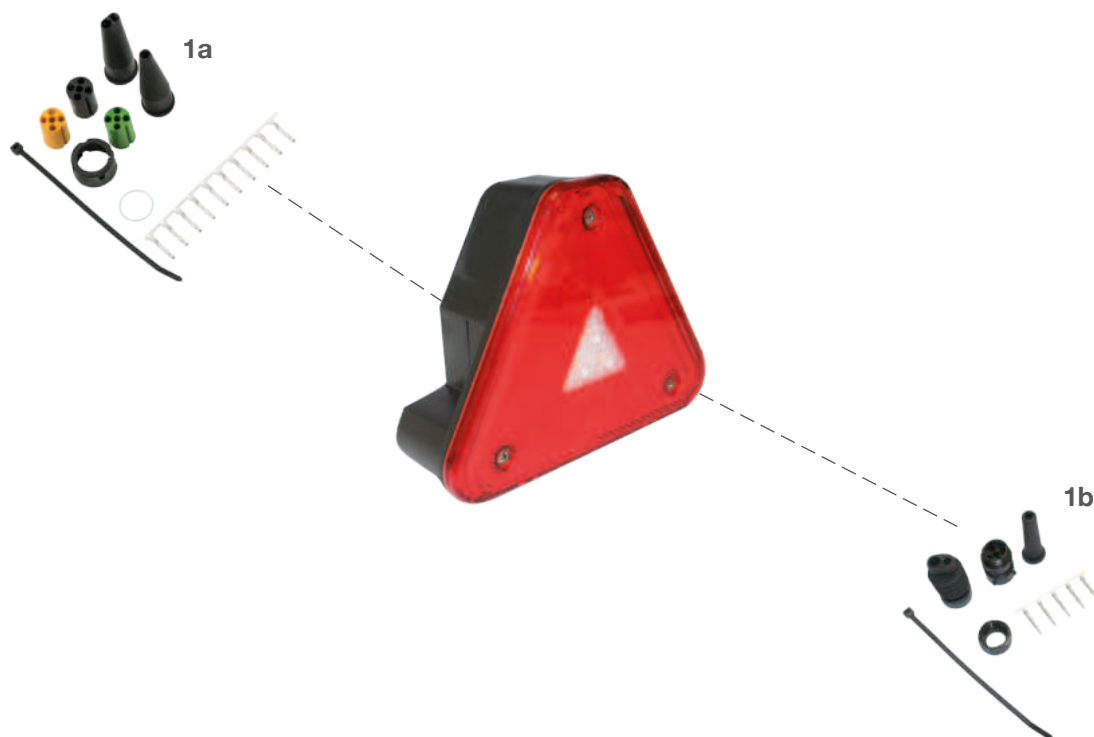

1 Bajonett Verbinder | bayonet connector

- (a) 5 pol. weiblich
5 pin female 13-0521-104
- (b) 5 pol. männlich
5 pin male 13-0536-044



MINILED III

ADR Zone 2 IP 6K9K



Produktinformation
Product information

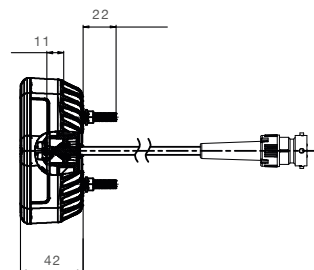
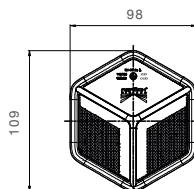

Blinklicht Direction indicator	Rücklicht Tail light	Bremslicht Stop light	

BEST. NR		←	→			ZUSATZ	ANSCHLUSS	
PART NO						ADD ON	CONNECTOR	
33-7234-001	1/-	●	●	LED	12V		5 pol. Bajonett 5 pin Bayonet	♂ 0,50 m
33-7234-011	1/-	●	●	LED	12V		5 pol. Bajonett 5 pin Bayonet	♂ 0,50 m
33-7234-071	1/-	●	●	LED	12/24V		5 pol. Bajonett 5 pin Bayonet	♂ 0,50 m
33-7234-081	1/-	●	●	LED	12/24V		5 pol. Bajonett 5 pin Bayonet	♂ 0,50 m
33-7234-021	1/-	●	●	LED	12V		offenes Ende open end	0,50 m
33-7234-031	1/-	●	●	LED	12V		offenes Ende open end	0,50 m
33-7234-051	1/-	●	●	LED	12/24V		offenes Ende open end	0,50 m
33-7234-061	1/-	●	●	LED	12/24V		offenes Ende open end	0,50 m
33-7234-041	1/-	●	●	LED	12/24V		offenes Ende open end	0,50 m



MINILED III

ZUBEHÖR / ACCESSORIES

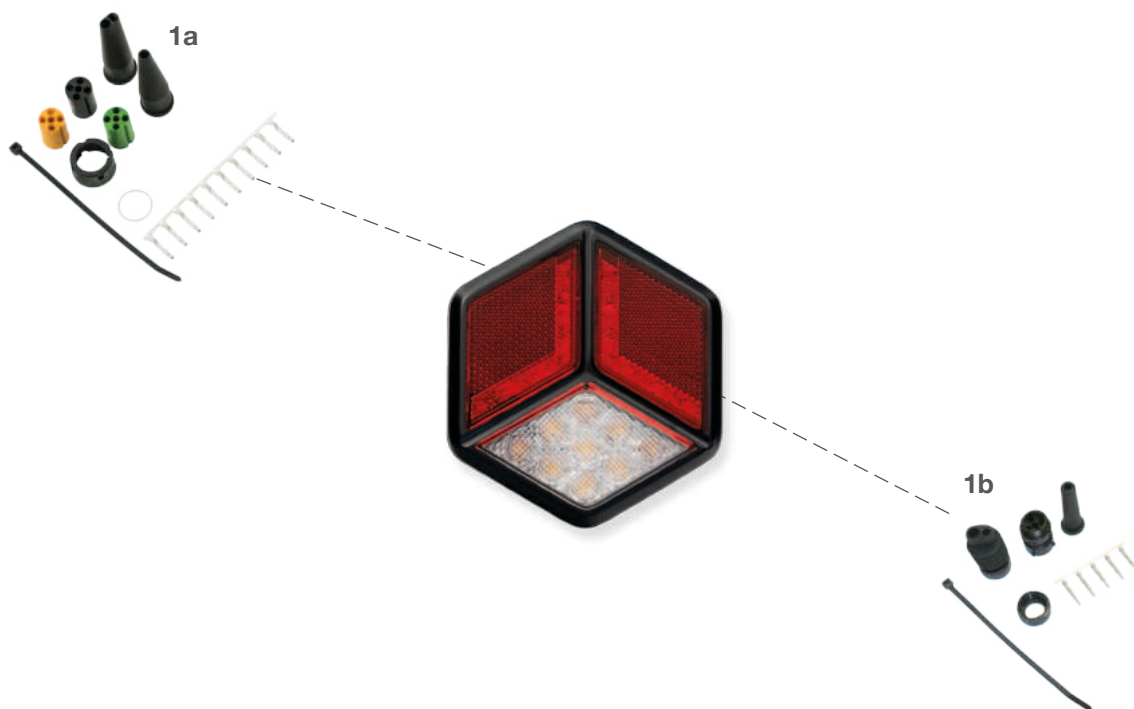

1 Bajonett Verbinder | bayonet connector

- (a) 5 pol. weiblich
5 pin female 13-0521-104
- (b) 5 pol. männlich
5 pin male 13-0536-044