

FAWSPÖCK®

SPARE PARTS



## **RÜCKFAHRLEUCHE ARBEITSSCHEINWERFER**

Unsere Rückfahr- und Arbeitsscheinwerfer werden unter extremen Bedingungen für maximale Beständigkeit entwickelt. Langlebigkeit, eine hohe Lichtleistung und eine geringe Stromaufnahme sorgen dafür, dass die Arbeitsumgebung auch bei schlechten Lichtverhältnissen und jedem Wetter optimal ausgeleuchtet ist.

## **REVERSE LAMP WORKING LAMP**

Our reverse lamps and working lamps have been developed under extreme conditions for maximum durability. Longevity, high illumination output and low power consumption ensure that the working environment is optimally lightened even in low light conditions and in all weather conditions.





# WORKPOINT II 1000

ADR Zone 2 IP 6K9K



Produktinformation  
Product information

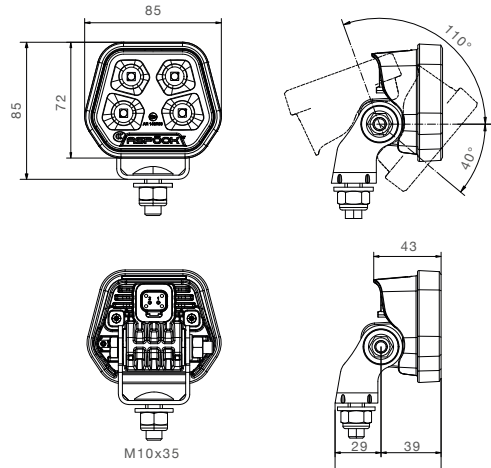

- Rückfahrlicht  
Reverse light
- Arbeitsscheinwerfer  
Working light

BEST. NR				ZUSATZ	ANSCHLUSS
PART NO				ADD ON	CONNECTOR
28-8524-011	1/24		12V/24V		2 pol. Deutsch
38-8524-011	1/24		12V/24V		offenes Ende open end <span style="float: right;">1,50 m </span>
38-8524-061	1/24		12V/24V		2 pol. ASS2 <span style="float: right;">1,50 m </span>

Rückfahrleuchte  
Arbeitsscheinwerfer  
Reverse Lamp  
Working Lamp



# WORKPOINT II 1500

ADR Zone 2 IP 6K9K



Produktinformation  
Product information

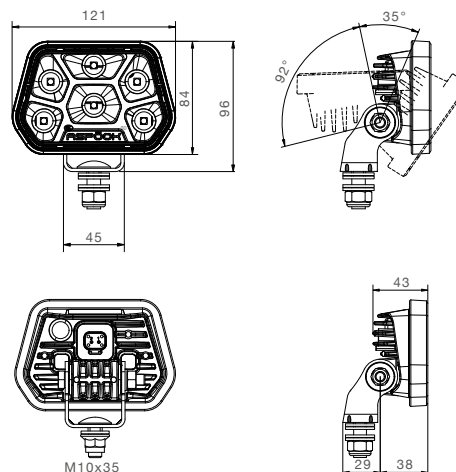

Rückfahrlicht  
Reverse light
 Arbeitsscheinwerfer  
Working light

BEST. NR				ZUSATZ	ANSCHLUSS	
PART NO				ADD ON	CONNECTOR	
28-8524-001	1/24	LED	12V/24V	1500 LUMEN 14W FLOOD	-40°C - +50°C	2 pol. Deutsch 2 pin Deutsch
38-8524-001	1/24	LED	12V/24V	1500 LUMEN 14W FLOOD	-40°C - +50°C	offenes Ende open end 1,50 m
38-8524-071	1/24	LED	12V/24V	1500 LUMEN 14W FLOOD	-40°C - +50°C	offenes Ende open end 7,00 m
38-8524-051	1/24	LED	12V/24V	1500 LUMEN 14W FLOOD	-40°C - +50°C	2 pol. ASS2 2 pin ASS2  1,50 m
38-8524-081	1/24	LED	12V/24V	1500 LUMEN 14W FLOOD	-40°C - +50°C	2 pol. ASS2 2 pin ASS2  7,00 m

Rückfahrleuchte  
Arbeitsscheinwerfer  
Reverse Lamp  
Working Lamp



# WORKPOINT II 3000







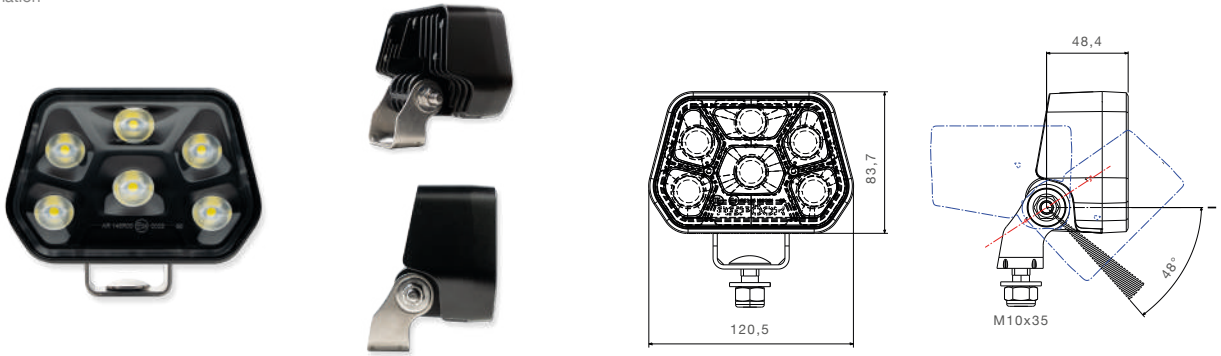



ADR Zone 2 IP 6K9K



Produktinformation  
Product information



 Rückfahrlicht Reverse light	 Arbeitsscheinwerfer Working light
--	--

BEST. NR				ZUSATZ	ANSCHLUSS				
PART NO				ADD ON	CONNECTOR				
28-8524-041	1/16	LED	12V/24V	3000 LUMEN 35W SPOT	60° Abstrahlwinkel radiation angle	-40°C - +50°C	2 pol. Deutsch 2 pin Deutsch	 	
38-8524-041	1/16	LED	12V/24V	3000 LUMEN 35W SPOT		-40°C - +50°C	offenes Ende open end	1,50 m	
28-8524-031	1/16	LED	12V/24V	3000 LUMEN 35W FLOOD	20° Abstrahlwinkel radiation angle	-40°C - +50°C	2 pol. Deutsch 2 pin Deutsch	 	
38-8524-031	1/16	LED	12V/24V	3000 LUMEN 35W FLOOD		-40°C - +50°C	offenes Ende open end	1,50 m	

Rückfahrlicht  
Arbeitsscheinwerfer  
Reverse Lamp  
Working Lamp





WORKPOINT II 1000 / 1500 / 3000

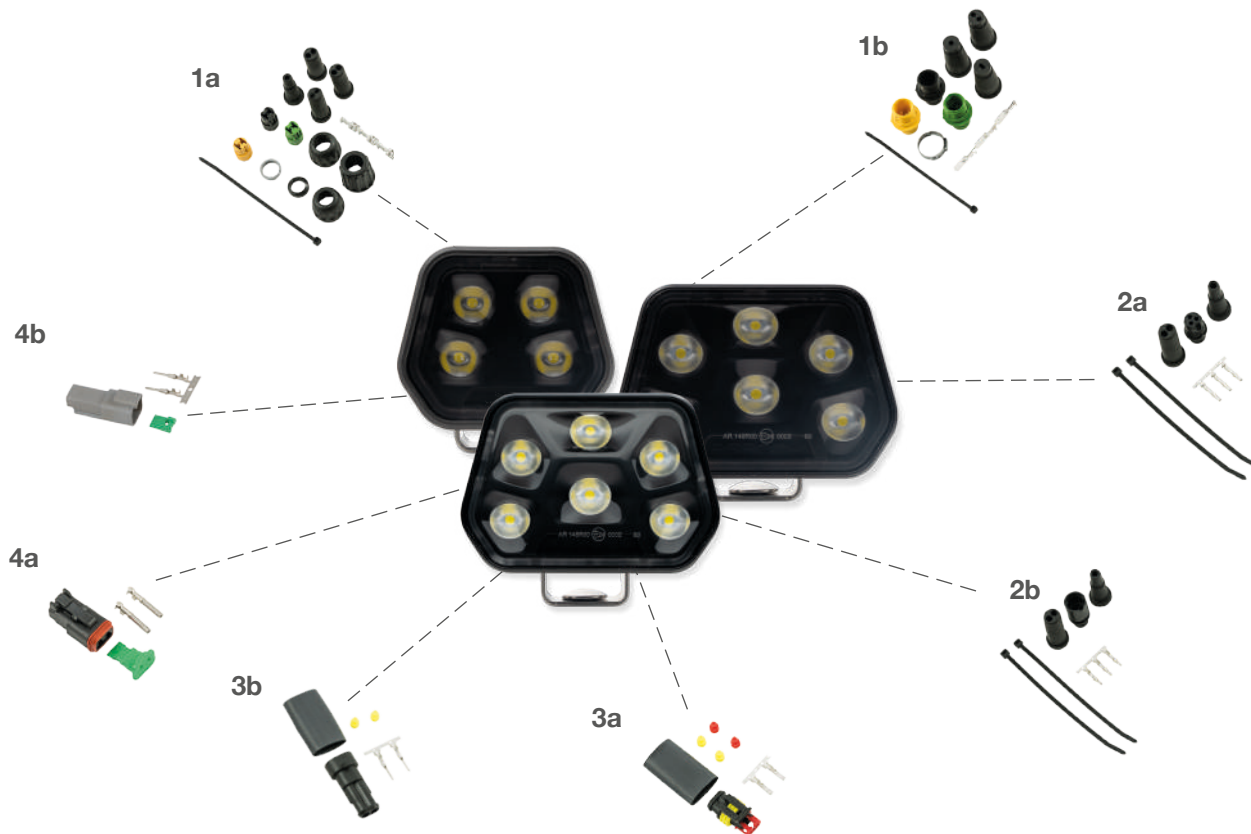

ZUBEHÖR / ACCESSORIES



**1** ASS1 & ASS2 Verbinder |  
ASS1 & ASS2 connector

- (a) 2 pol. weiblich  
2 pin female ..... 13-5626-401 
- (b) 2 pol. männlich  
2 pin male ..... 13-5625-991 



**2** ASS3 Verbinder | ASS3 connector

- (a) 2 pol. weiblich  
2 pin female ..... 13-0322-281 
- (b) 2 pol. männlich  
2 pin male ..... 13-0332-281 

**3** Superseal Verbinder | Superseal connector

- (a) 2 pol. weiblich  
2 pin female ..... 15-7002-044 
- (b) 2 pol. männlich  
2 pin male ..... 15-7002-054 

**4** Deutsch Verbinder | Deutsch connector

- (a) 2 pol. weiblich  
2 pin female ..... 15-7002-135 
- (b) 2 pol. männlich  
2 pin male ..... 15-7002-125 



WORKPOINT II 1000 / 1500 / 3000





ZUBEHÖR / ACCESSORIES



**5 Halterung | bracket**

- (a) Omega Halterung  
omega bracket ..... 14-4302-224 

**6 Deutsch Verlängerungskabel |  
Deutsch extension cable**

- (a) Verlängerung DT Version 3,00 m  
extension for DT version 3,00 m  
..... 69-0236-014 
- (b) Verlängerung DT Version 5,00 m  
extension for DT version 5,00 m  
..... 69-0236-004 
- (c) Verlängerung DT Version 6,50 m  
extension for DT version 6,50 m  
..... 69-0236-054 
- (d) Verlängerung DT Version 8,00 m  
extension for DT version 8,00 m  
..... 69-0236-024 
- (e) Verlängerung DT Version 10,00 m  
extension for DT version 10,00 m  
..... 69-0236-034 
- (f) Verlängerung DT Version 12,00 m  
extension for DT version 12,00 m  
..... 69-0236-044 



# FLATPOINT IV

## Position lamp | Positionsleuchte

- >> LED-Positionslicht mit integriertem Glowing Body | *LED position light with integrated Glowing Body*
- >> In der höchsten Schutzklasse IP6K9K geprüft | *Tested in the highest protection class IP 6K9K*





# WORKPOINT LED 1500





ADR Zone 2 IP 6K9K

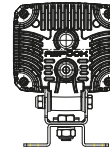
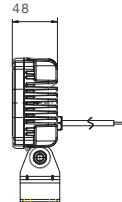
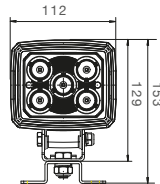

Produktinformation  
Product information



 Rückfahrlicht Reverse light	 Arbeitsscheinwerfer Working light
--	--

BEST. NR				ZUSATZ	ANSCHLUSS
PART NO				ADD ON	CONNECTOR
38-8220-001	1/12	<b>LED</b>	12V 24V	<b>1500 LUMEN</b> <b>25W</b>  -40°C bis +80°C	offenes Ende open end <span style="float: right;">1,50 m </span>



# WORKPOINT LED 1500

## ZUBEHÖR / ACCESSORIES

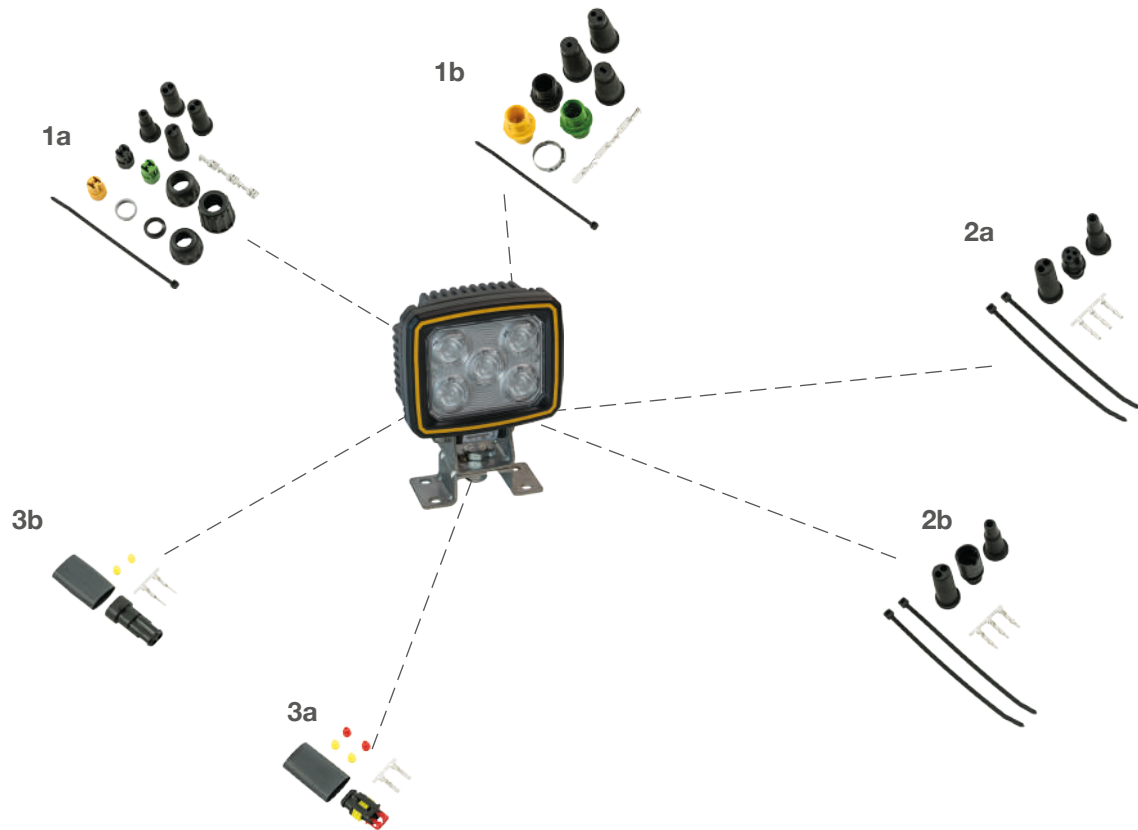

### 1 ASS1 & ASS2 Verbinder | ASS1 & ASS2 connector

- (a) 2 pol. weiblich  
2 pin female ..... 13-5626-401
- (b) 2 pol. männlich  
2 pin male ..... 13-5625-991

### 2 ASS3 Verbinder | ASS3 connector

- (a) 3 pol. weiblich  
3 pin female ..... 13-0322-281
- (b) 3 pol. männlich  
3 pin male ..... 13-0332-281

### 3 Superseal Verbinder | Superseal connector

- (a) 2 pol. weiblich  
2 pin female ..... 15-7002-044
- (b) 2 pol. männlich  
2 pin male ..... 15-7002-054





# WORKPOINT LED 1500

ZUBEHÖR / ACCESSORIES

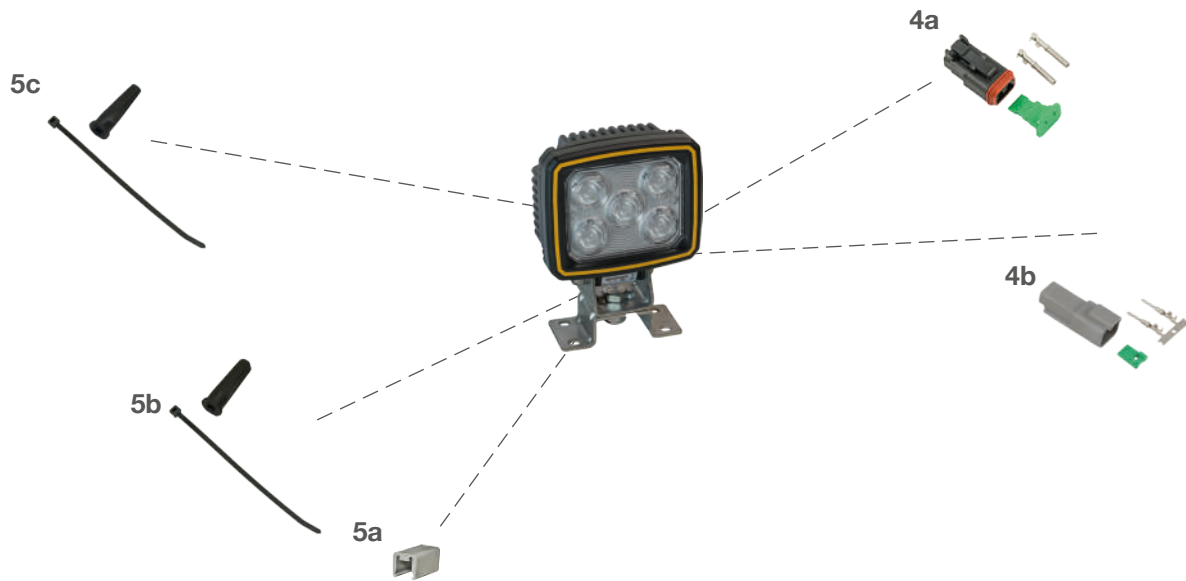

## 4 Deutsch Verbinder | Deutsch connector

- (a) 2 pol. weiblich  
2 pin female ..... 15-7002-135
- (b) 2 pol. männlich  
2 pin male ..... 15-7002-125

## 5 für P&R Verbinder | for P&R connector

- (a) Verschlusskappen  
caps ..... 15-5971-014
- (b) Endkappen rund  
end caps round ..... 15-5983-024
- (c) Endkappen eckig  
end caps square ..... 15-5729-014

THE ART OF LIGHTS



# RADDC 1.0

Rückraumüberwachung für Lkw und Anhänger  
Rear area monitoring for trucks & trailers

[aspoeck.com](http://aspoeck.com)









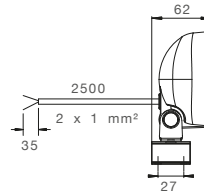
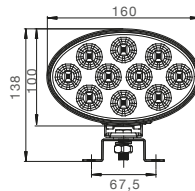











# RÜCKFAHRSCHEINWERFER LED / REVERSE LAMP LED

ADR  
Zone 2

IP 56K



 Rückfahrlicht  
Reverse light

BEST. NR				ZUSATZ	ANSCHLUSS
PART NO				ADD ON	CONNECTOR
38-8200-001	1/-		12V/ 24V	 200 LUMEN -40°C - +80°C	offenes Ende open end 2,50 m 
38-8207-001	1/-		12V/ 24V	 200 LUMEN -40°C - +80°C	2 pol. ASS2    2,50 m 
38-8207-011	1/20		12V/ 24V	 200 LUMEN -40°C - +80°C	2 pol. Superseal    2,50 m 

Rückfahrlicht  
Arbeitscheinwerfer  
Reverse Lamp  
Working Lamp



# RÜCKFAHRSCHEINWERFER LED / REVERSE LAMP LED

ZUBEHÖR /  
ACCESSORIES



## 1 ASS1 & ASS2 Verbinder | ASS1 & ASS2 connector

- (a) 2 pol. weiblich  
2 pin female ..... 13-5626-401
- (b) 2 pol. männlich  
2 pin male ..... 13-5625-991

## 2 Superseal Verbinder | Superseal connector

- (a) 2 pol. weiblich  
2 pin female ..... 15-7002-044
- (b) 2 pol. männlich  
2 pin male ..... 15-7002-054









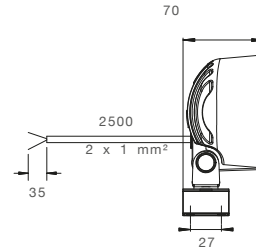
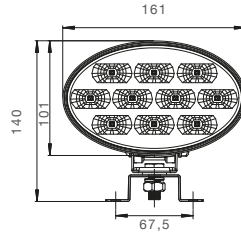













# WORKPOINT LED 800

ADR  
Zone 2

IP 56K



 Arbeitsscheinwerfer  
Working light

BEST. NR				ZUSATZ	ANSCHLUSS
PART NO				ADD ON	CONNECTOR
39-6800-011	1/-		12V/ 24V	 	offenes Ende open end 2,50 m 
39-6801-001	1/-		12V/ 24V	 	2 pol. Superseal    2 pin Superseal
39-6807-001	1/-		12V/ 24V	 	2 pol. ASS2    2 pin ASS2 2,50 m 



# WORKPOINT LED 800

ZUBEHÖR / ACCESSORIES

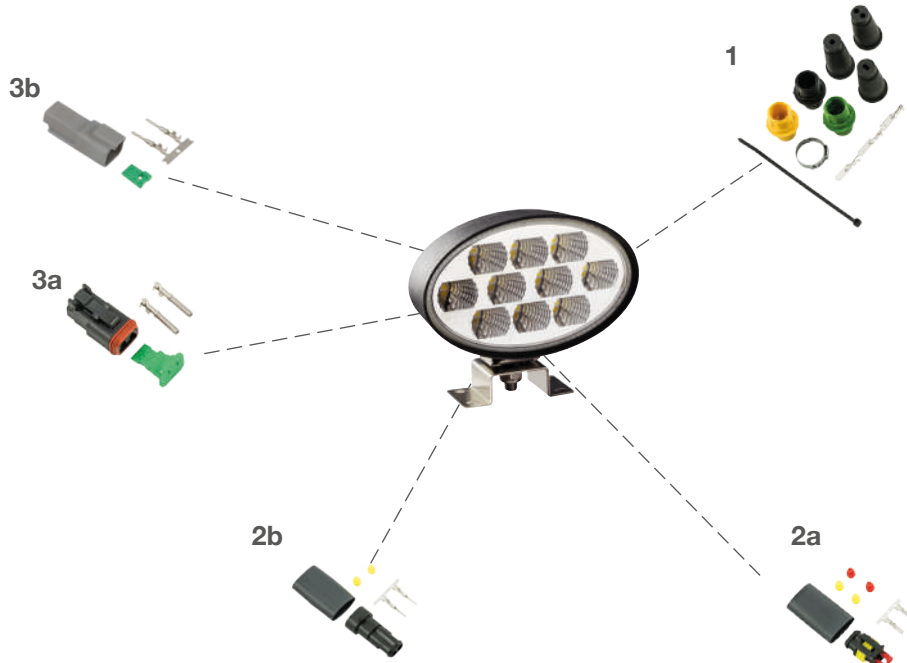

## 1 ASS1 & ASS2 Verbinder | ASS1 & ASS2 connector

- (a) 2 pol. weiblich  
2 pin female ..... 13-5626-401
- (b) 2 pol. männlich  
2 pin male ..... 13-5625-991

## 2 Superseal Verbinder | Superseal connector

- (a) 2 pol. weiblich  
2 pin female ..... 15-7002-044
- (b) 2 pol. männlich  
2 pin male ..... 15-7002-054

## 3 Deutsch Verbinder | Deutsch connector

- (a) 2 pol. weiblich  
2 pin female ..... 15-7002-135
- (b) 2 pol. männlich  
2 pin male ..... 15-7002-125











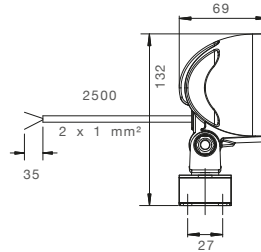
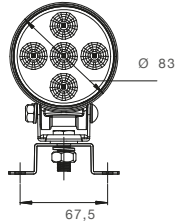





























# WORKPOINT LED 650

ADR  
Zone 2

IP 56K



 Arbeitsscheinwerfer  
Working light

BEST. NR				ZUSATZ	ANSCHLUSS
PART NO				ADD ON	CONNECTOR
39-6400-011	1/20		12V/ 24V	 	offenes Ende open end 2,50 m 
39-6400-031	1/-		12V/ 24V	 	2 pol. Superseal 2 pin Superseal    2,50 m 
39-6407-001	1/20		12V/ 24V	 	2 pol. ASS2 2 pin ASS2    2,50 m 
39-6407-011	1/-		12V/ 24V	 	2 pol. ASS2 2 pin ASS2    1,50 m 
39-6400-041	1/20		12V/ 24V	 	2 pol. Deutsch 2 pin Deutsch    0,30 m 



# WORKPOINT LED 650

## ZUBEHÖR / ACCESSORIES

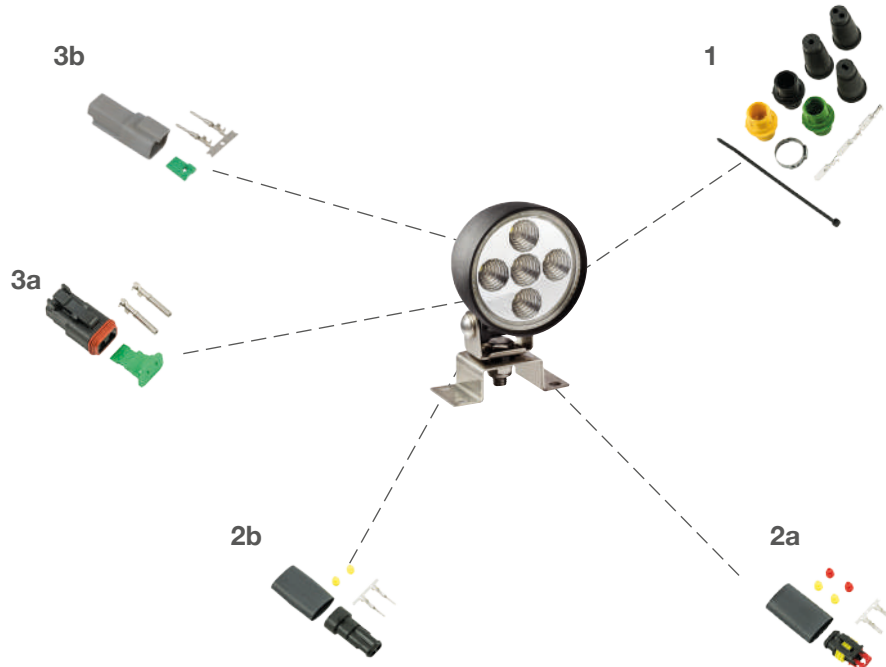

### 1 ASS1 & ASS2 Verbinder | ASS1 & ASS2 connector

- (a) 2 pol. weiblich  
2 pin female ..... 13-5626-401
- (b) 2 pol. männlich  
2 pin male ..... 13-5625-991

### 2 Superseal Verbinder | Superseal connector

- (a) 2 pol. weiblich  
2 pin female ..... 15-7002-044
- (b) 2 pol. männlich  
2 pin male ..... 15-7002-054

### 3 Deutsch Verbinder | Deutsch connector

- (a) 2 pol. weiblich  
2 pin female ..... 15-7002-135
- (b) 2 pol. männlich  
2 pin male ..... 15-7002-125



# RÜCKFAHRSCHEINWERFER / REVERSE LAMP ARBEITSSCHEINWERFER / WORKING LAMP

ADR Zone 2 IP 5K4K

21W

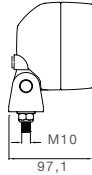
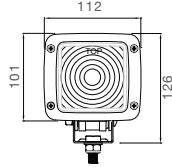

70W

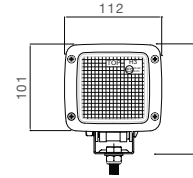

BEST. NR					ZUSATZ	ANSCHLUSS	
PART NO					ADD ON	CONNECTOR	
28-9100-001	1/-		24V		<b>70W</b>	Tülleneingang grommet	
38-9000-001	1/10		24V		<b>21W</b>	offenes Ende open end	2,50 m
38-9100-001	1/-		24V		<b>70W</b>	offenes Ende open end	2,50 m
38-9007-011	1/-		24V		<b>21W</b>	2 pol. ASS2 2 pin ASS2	2,50 m
38-9107-011	1/-		24V		<b>70W</b>	2 pol. ASS2 2 pin ASS2	2,50 m
38-9010-001	1/25		24V		<b>21W</b>	2 pol. Superseal 2 pin AMP	0,25 m
38-9100-081	1/10		24V		<b>70W</b>	2 pol. Deutsch 2 pin Deutsch	2,25 m

Rückfahrlicht  
Arbeitsscheinwerfer  
Reverse Lamp  
Working Lamp



# RÜCKFAHRSCHEINWERFER / REVERSE LAMP ARBEITSSCHEINWERFER / WORKING LAMP

ZUBEHÖR /  
ACCESSORIES

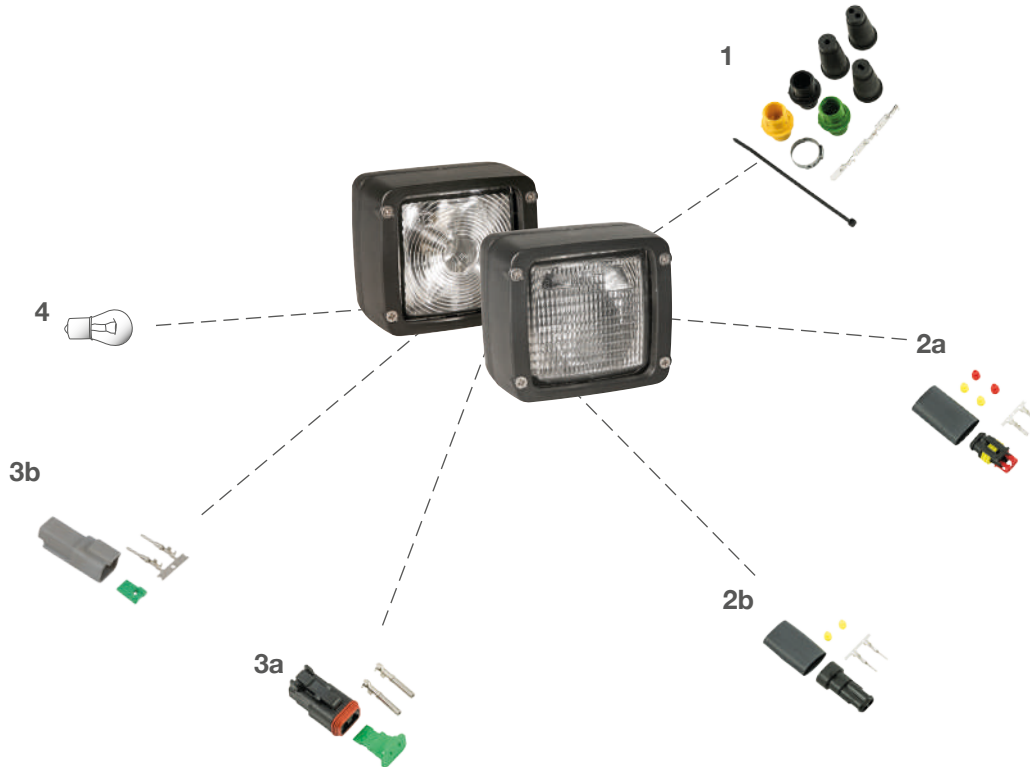

- 1 ASS1 & ASS2 Verbinder | ASS1 & ASS2 connector**
- (a) 2 pol. weiblich  
2 pin female ..... 13-5626-401
  - (b) 2 pol. männlich  
2 pin male ..... 13-5625-991
- 2 Superseal Verbinder | Superseal connector**
- (a) 2 pol. weiblich  
2 pin female ..... 15-7002-044
  - (b) 2 pol. männlich  
2 pin male ..... 15-7002-054

- 3 Deutsch Verbinder | Deutsch connector**
- (a) 2 pol. weiblich  
2 pin female ..... 15-7002-135
  - (b) 2 pol. männlich  
2 pin male ..... 15-7002-125
- 4 Glühlampe | bulb**
- 24V 70W H3..... 16-6456-001

Rückfahrleuchte  
Arbeitscheinwerfer  
Reverse Lamp  
Working Lamp