

ASPÖCK®
S Y S T E M S

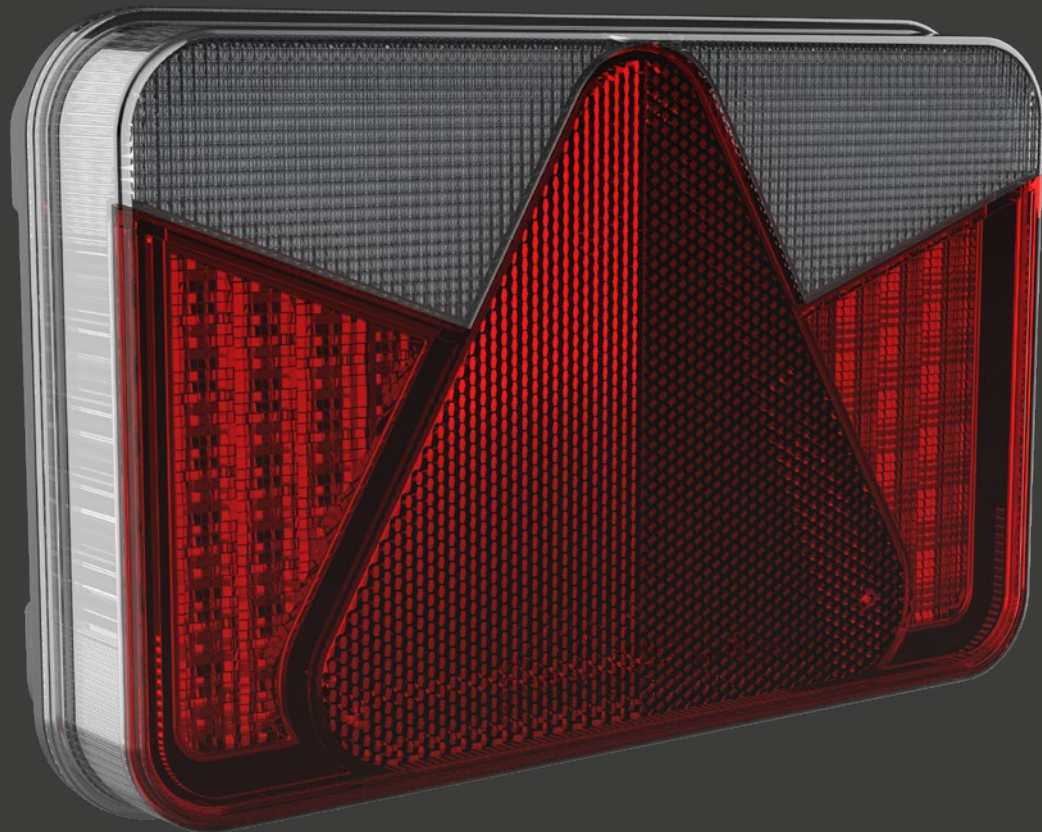

MOUNTING INSTRUCTION

MULTILED V

MONTAGEANLEITUNG

MOUNTING INSTRUCTION



aspoeck.com





SERVICEHINWEISE SERVICE NOTES

- Vor Beginn der Montage die gesamte Montageanleitung sorgfältig durchlesen.
 - Diese Montageanleitung richtet sich an professionelle Aufbauhersteller und setzt entsprechendes Fachwissen voraus. Es ist zu beachten, dass bestimmte Arbeiten ausschließlich von qualifiziertem Personal ausgeführt werden dürfen, um Verletzungsrisiken zu minimieren und die erforderliche Qualität der Aufbauarbeiten sicherzustellen.
 - Im Rahmen von Produktverbesserungen behalten wir uns technische und optische Änderungen vor.
 - Bei Fragen oder Einbauproblemen den Aspöck-Kundendienst, einen Händler oder die Vertragswerkstatt kontaktieren.
 - Auf die ordnungsgemäße Trennung sowie die fachgerechte Entsorgung der Verpackungen, Hilfsmittel und Komponenten achten.
-
- Read the entire mounting instructions carefully before starting assembly.
 - These mounting instructions are intended for professional vehicle body manufacturer and require appropriate expertise. Please note that certain work may only be carried out by qualified staff in order to minimise the risk of injury and to ensure the required quality of the assembly work.
 - We reserve the right to make technical and visual changes in the course of product improvements.
 - If you have any questions or installation problems, please contact Aspöck customer service, a dealer or the authorised workshop.
 - Ensure that packaging, auxiliary materials and components are properly separated and disposed of correctly.



ALLGEMEIN GENERAL

Die MULTILED V ist eine Voll-Led-Mehrfunktionsleuchte, die an der hinteren Grenzkontur eines Anhängers zu finden und nach hinten gerichtet ist. Sie besteht aus folgenden Einzelfunktionen, die in einem Leuchtenkörper kombiniert sind: **Fahrtrichtungsanzeiger, Rückleuchte, Bremsleuchte, Nebelschlussleuchte, Rückfahrcheinwerfer, Retroreflexion und optionaler Kennzeichenbeleuchtung.**

The MULTILED V is a full LED multi-function light that is located at the rear edge of a trailer and faces backwards. It combines the following individual functions in a single lamp body: **direction indicator, tail light, stop light, fog light, reversing light, retro-reflection and optional number plate lighting.**

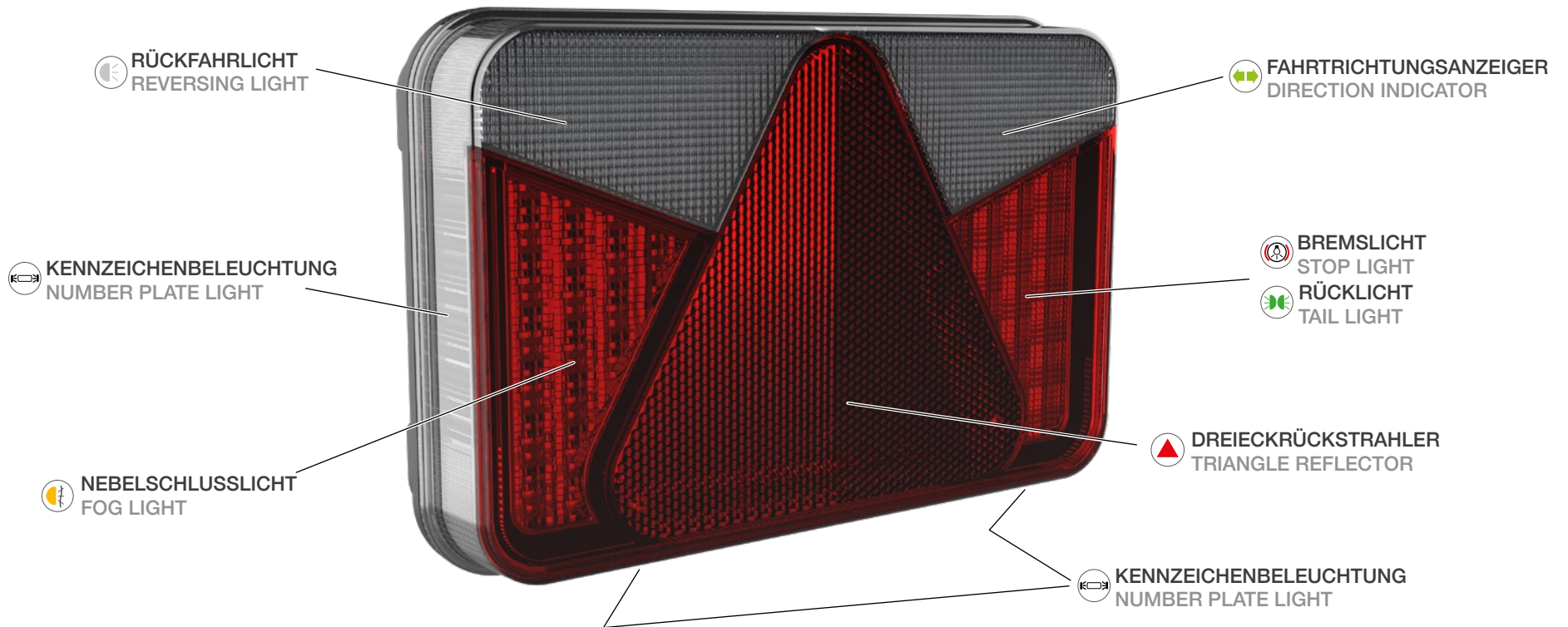



SYMBOLERKLÄRUNG EXPLANATION SYMBOLS



RICHTIG
CORRECT



FALSCH
INCORRECT



POSITIONSPFEIL
POSITION ARROW



BEWEGUNGSPFEIL
MOVEMENT ARROW



ACHTUNG
WARNING



SEHEN - KONTROLLIEREN
LOOK - CONTROL

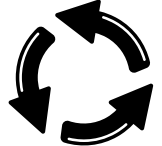

DREHEN
TWIST

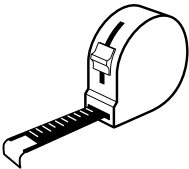

MESSEN
MEASURE

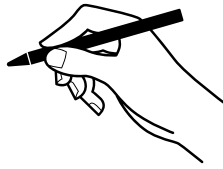

MARKIEREN
MARK



ANKÖRNEN
CENTRE PUNCH

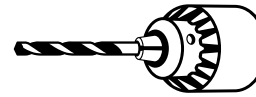

BOHREN KLEIN
DRILL SMALL

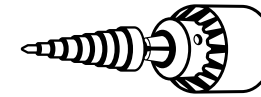

BOHREN GROSS
DRILL BIG



KORROSIONSSCHUTZ
CORROSION PROTECTION



ENTSORGEN
RECYCLE



SÄUBERN
CLEAN

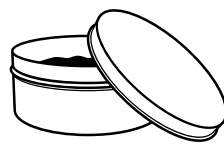

KONTAKTFETT
CONTACT GREASE

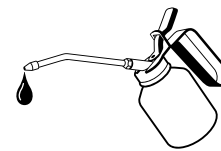

ÖLEN
OILING

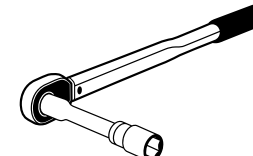

DREHMOMENTSCHLÜSSEL
TORQUE WRENCH



SCHRAUBENDREHER
SCREWDRIVER



SICHERHEITSHINWEISE SAFETY INSTRUCTIONS

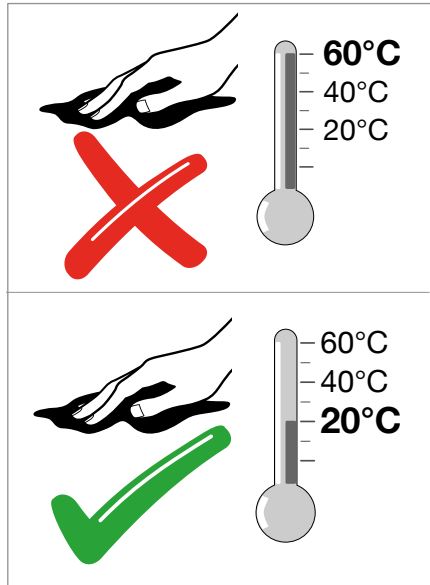

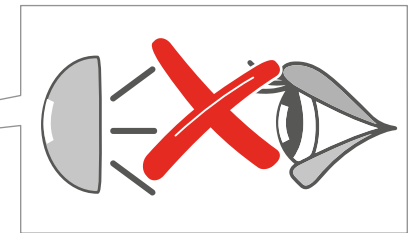
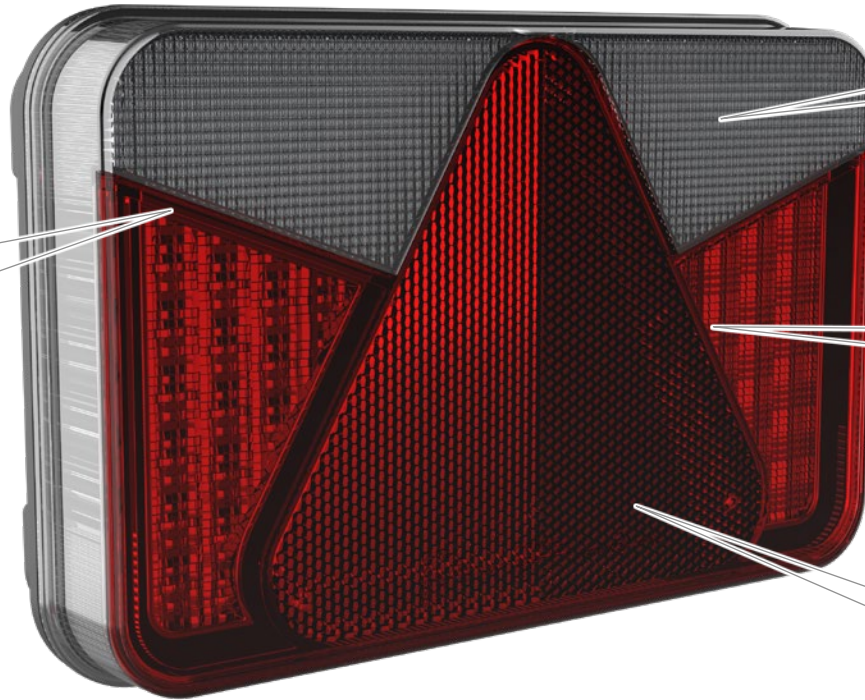

60°C
40°C
20°C

60°C
40°C
20°C



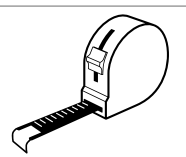
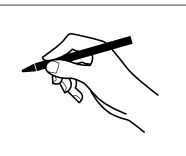
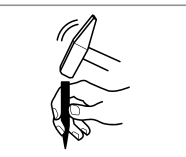
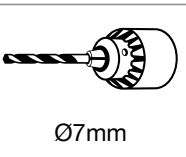
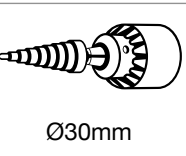

BOHRBILD LINKS HOLE PATTERN LEFT

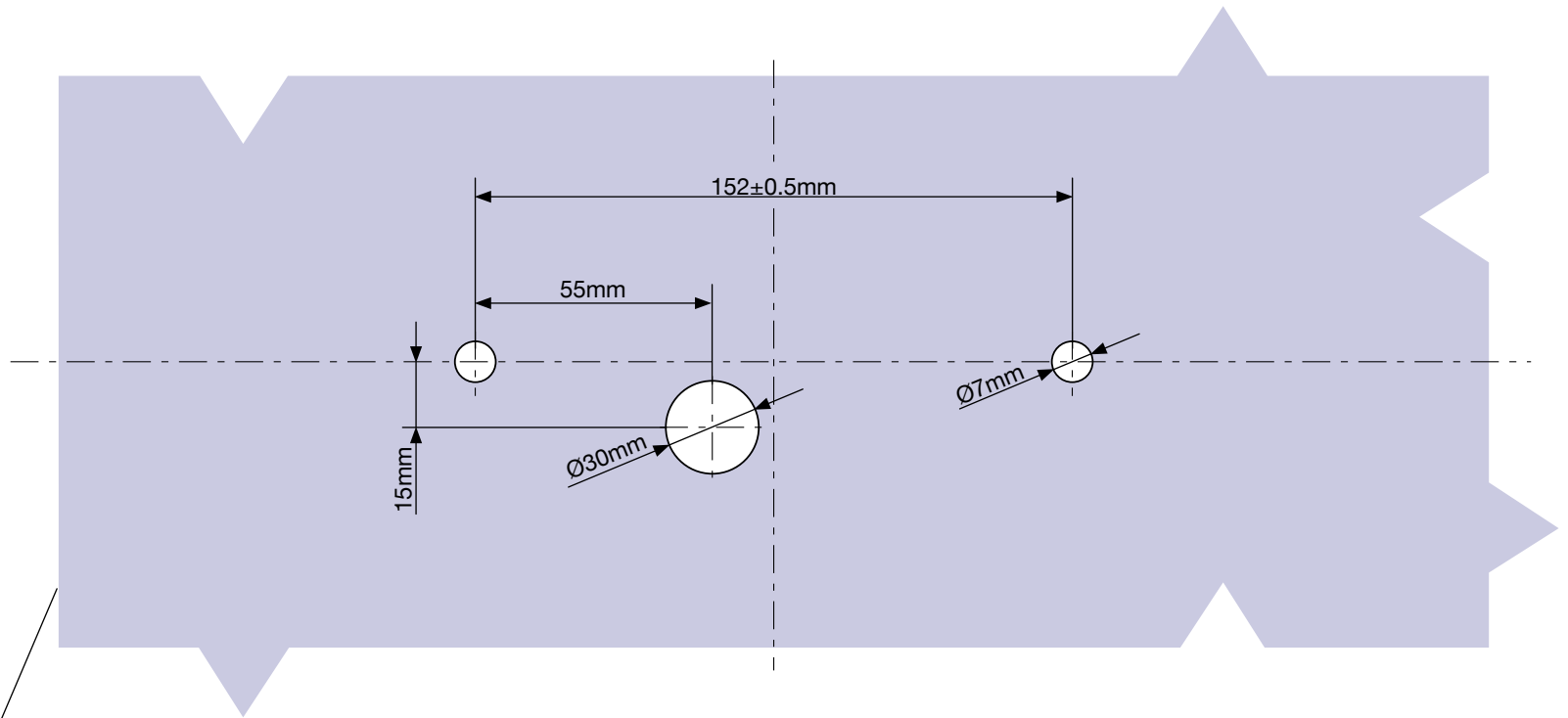

- ① 
- ② 
- ③ 
- ④ 
Ø7mm
- ⑤ 
Ø30mm
- ⑥ 



Fahrzeugaußenkante
outer edge of the vehicle

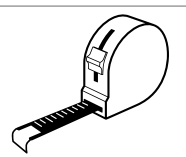
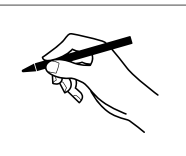
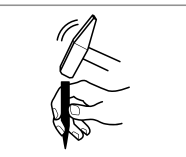
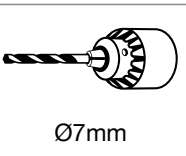
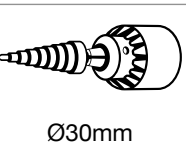

BOHRBILD RECHTS HOLE PATTERN RIGHT

- ① 
- ② 
- ③ 
- ④ 
Ø7mm
- ⑤ 
Ø30mm
- ⑥ 

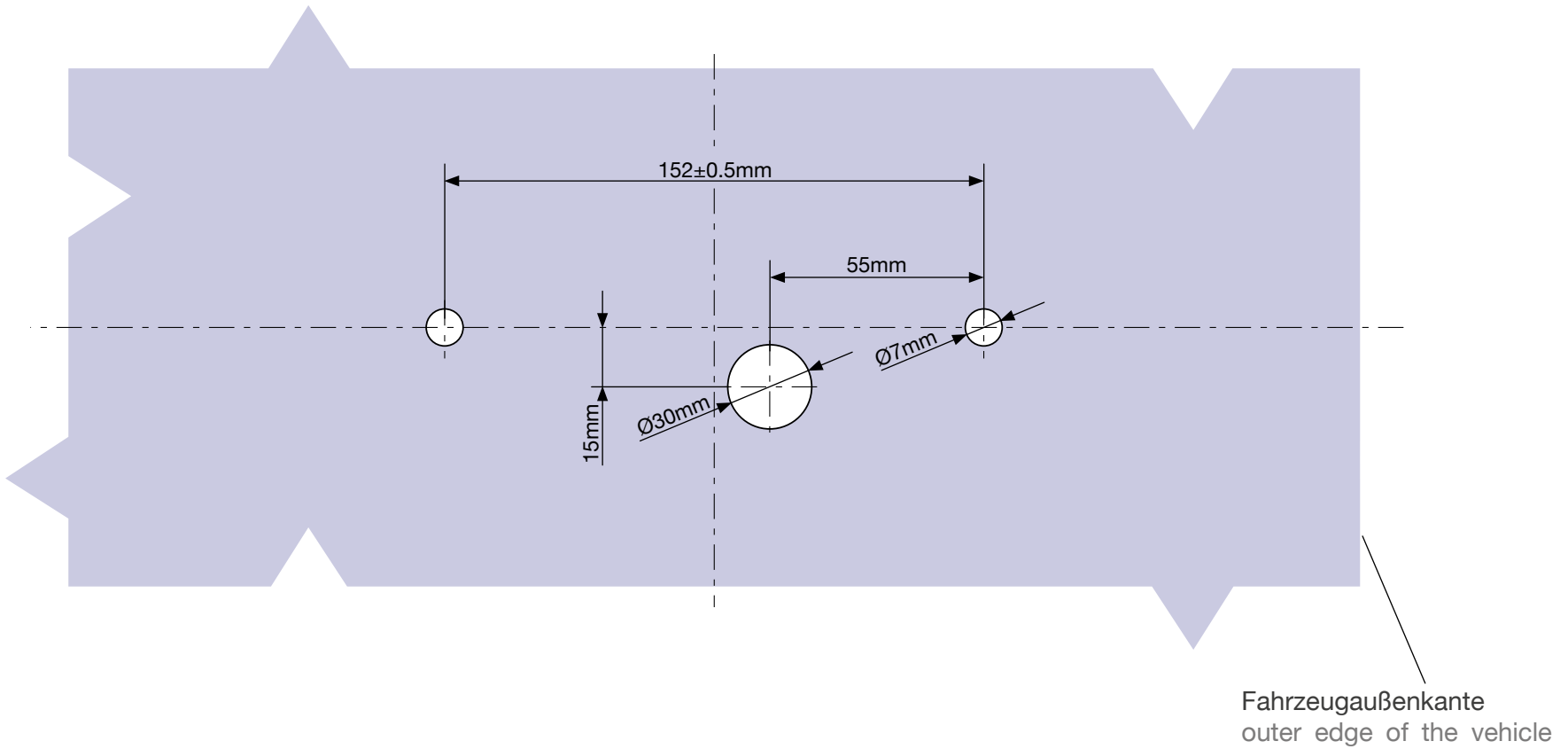



MONTAGE MOUNTING

①, ②

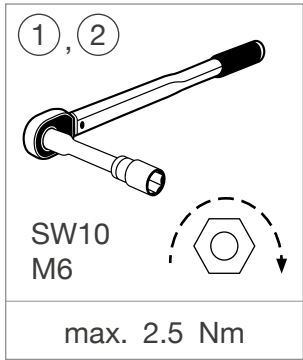

SW10
M6

max. 2.5 Nm

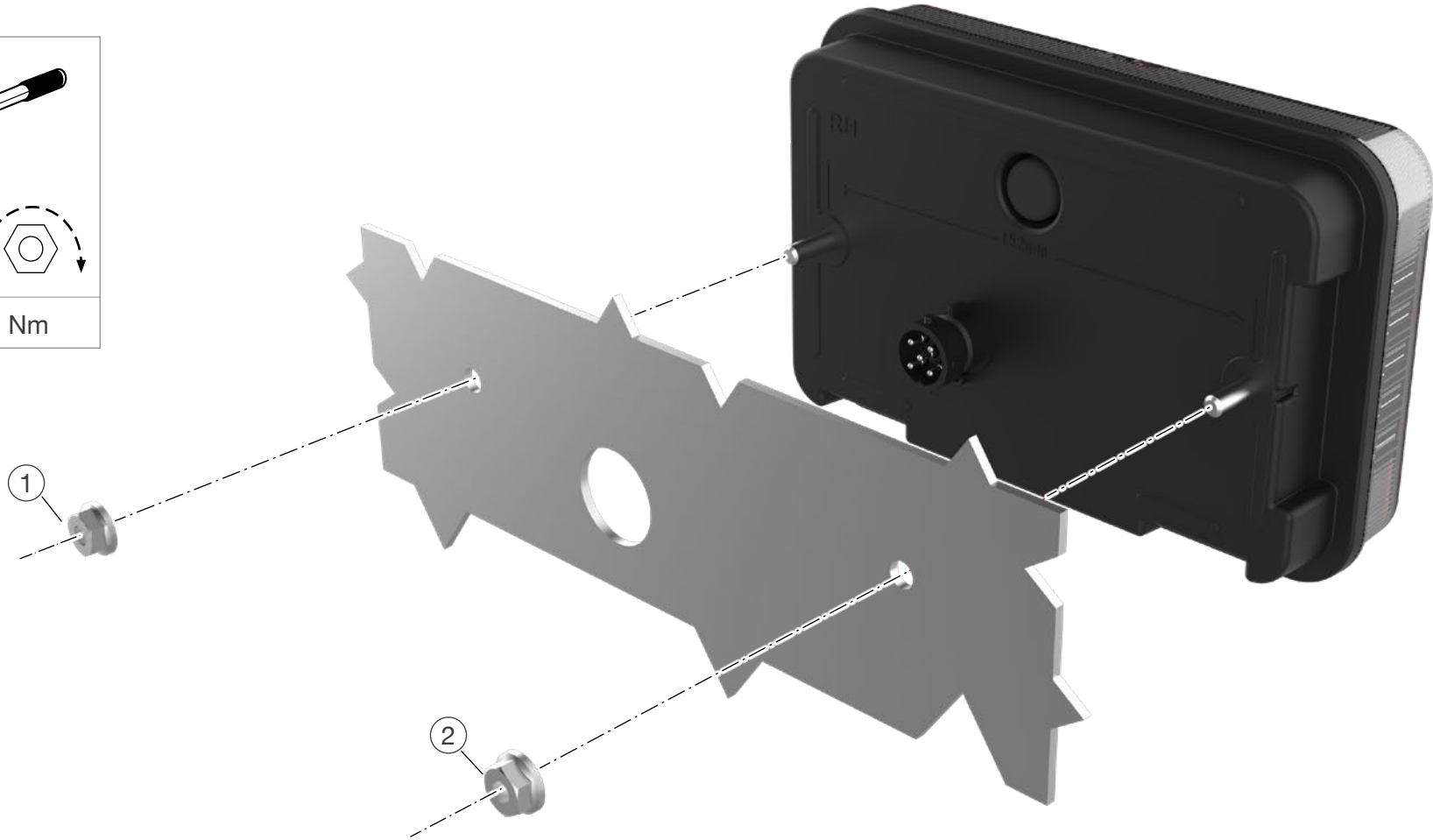







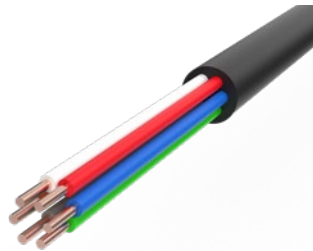
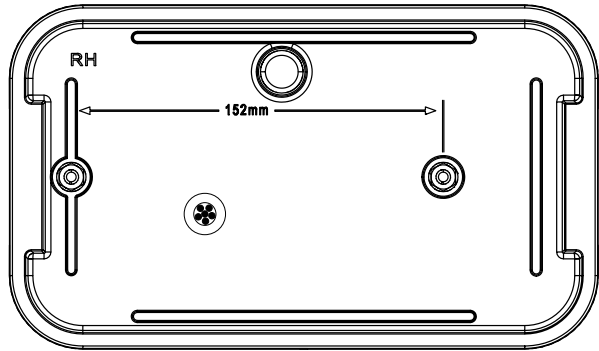







ANSCHLÜSSE KABEL 6 POL. OFFENES ENDE CONNECTORS CABLE 6 PIN OPEN-END









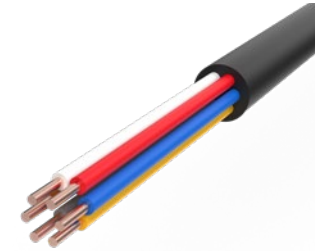
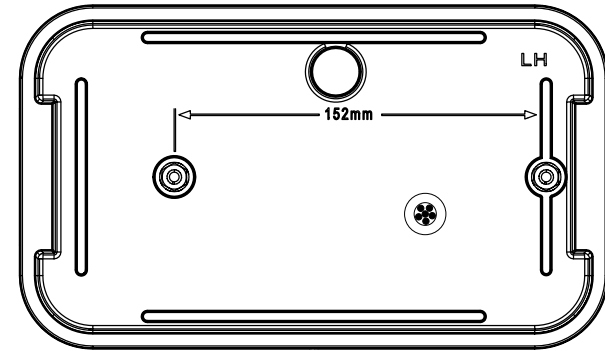



RECHTS:
RIGHT:



					
GND	Tail RH (NPL)	Stop	DI RH	Fog	Reverse
					

LINKS:
LEFT:









					
GND	Tail LH (NPL)	Stop	DI LH	Fog	Reverse
					

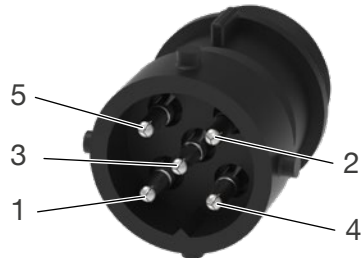
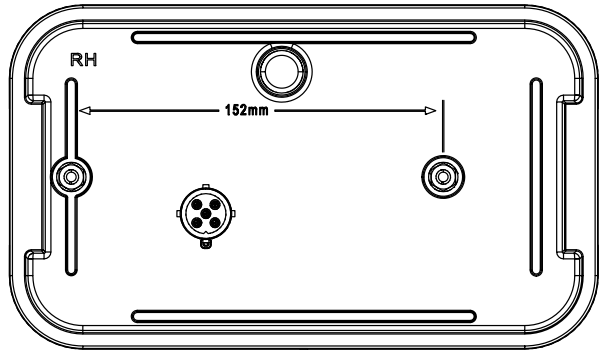

ANSCHLÜSSE BAJONETT 5 PIN CONNECTORS BAYONET 5 PIN





RECHTS:
RIGHT:

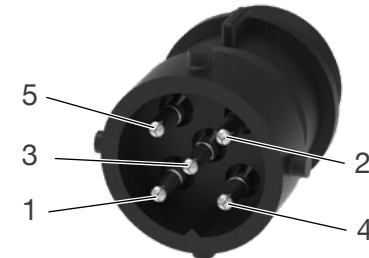
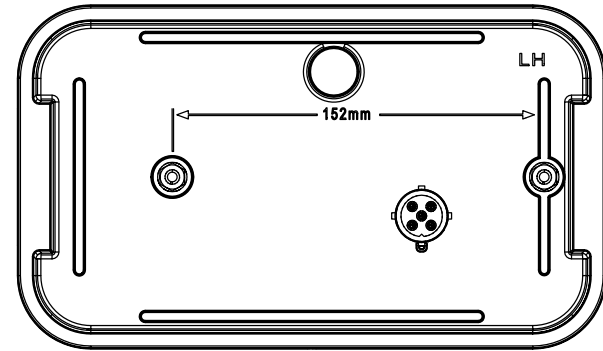

1	2	3	4	5
DI RH	Reverse	GND	Tail RH NPL	Stop
				

LINKS:
LEFT:

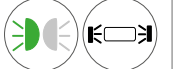







1	2	3	4	5
DI LH	Fog	GND	Tail LH NPL	Stop
				

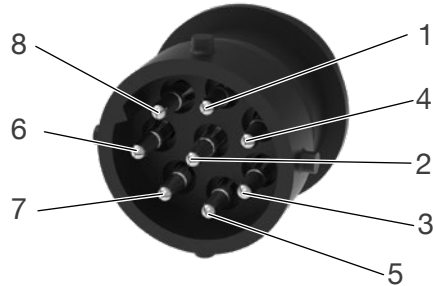
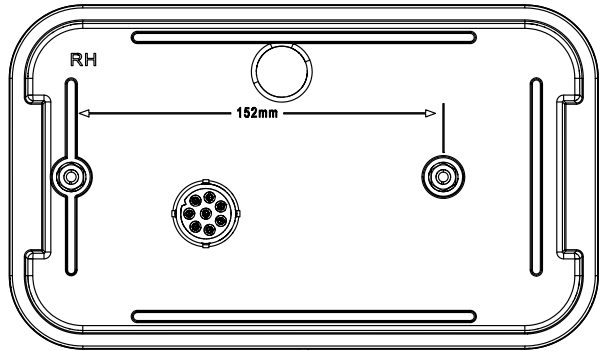

ANSCHLÜSSE BAJONETT 8 PIN CONNECTORS BAYONET 8 PIN





RECHTS:
RIGHT:

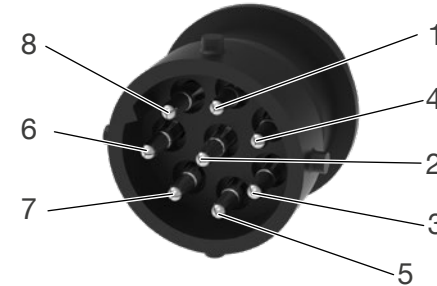
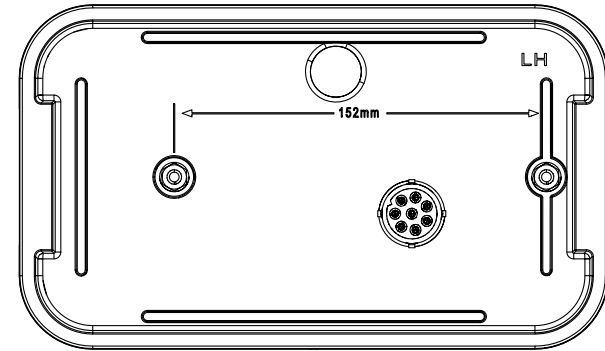

1	2	3	4	5	6	7	8
-	Fog	GND	DI RH	Tail RH	Stop	-	Reverse
-						-	

LINKS:
LEFT:



1	2	3	4	5	6	7	8
DI LH	Fog	GND	-	-	Stop	Tail LH	Reverse
			-	-			



PFLEGEANLEITUNG CARE INSTRUCTION

Lichtscheibe:

- Abspülen unter fließendem Wasser
- Bei Bedarf ein wenig Spülmittel (kein Scheuermittel!) verwenden
- Mit einem weichem Tuch oder Schwamm säubern und anschließend trocknen
- Kein Mikrofasertuch oder Scheuerschwamm verwenden

Lens:

- Rinse under running water
- Use a little detergent if necessary (not a scouring agent!)
- Clean with a soft cloth or sponge and then dry
- Do not use a microfibre cloth or scouring pad!

Beleuchtungsanlage auf einwandfreie Funktion hin prüfen.

Bei Fragen oder Einbauproblemen den Aspöck-Kundendienst, einen Händler oder die Vertragswerkstatt kontaktieren.

Check that the lighting system is working perfectly.

If you have any questions or installation problems, please contact Aspöck customer service, a dealer or the authorised workshop.



HAFTUNGSBESTIMMUNGEN LIABILITY PROVISIONS

Allgemeines:

- Nationale Anbau-, Einbau- und Betriebsvorschriften sind einzuhalten.
- Eine Verwendung darf ausschließlich gemäß beigelegten Anleitungen und Sicherheitshinweisen erfolgen. Anleitungen sind online auf der Website unter www.aspoeck.com zu finden.
- Änderungen am Produkt dürfen nicht vorgenommen werden, es sei denn es werden ausschließlich die hierfür vorgesehenen Original-Ersatzteile oder von Aspöck freigegebene Ersatzteile verwendet und von fachlich qualifiziertem Personal eingebaut.

Gewährleistungsausschluss:

- Bei Nichtbeachtung der in dieser Montageanleitung sowie der in dem Produktdatenblatt, angegebenen Hinweise und Informationen, bei nicht bestimmungsgemäßem Gebrauch, bei Einsatz außerhalb des vorgesehenen Verwendungszweckes bzw. außerhalb der vorgesehenen Einsatzbedingungen, ist die Gewährleistung für sämtliche Schäden am Produkt ausgeschlossen.
- Die Gewährleistung erstreckt sich weiters nicht auf Produkte, welche aufgrund von Gefahren (einschließlich Umweltgefahren, Gefahren im Straßenverkehr oder durch Dritte verursachte Gefahren oder Umstände, die außerhalb der Kontrolle von Aspöck liegen) beschädigt wurden oder sich in einem schlechten Betriebszustand befinden.
- Die Reparatur oder der Austausch eines mangelhaften Produktes löst nicht den Beginn einer neuen Gewährleistungsfrist aus.
- Weitere Gewährleistungsbestimmungen sind im Punkt 10 der Verkaufs- und Lieferbedingungen (VLB) www.aspoeck.com zu finden.

Haftungsausschluss:

- Aspöck Systems übernimmt keine Haftung für mittelbare Schäden, Folgeschäden und Vermögensschäden.
- Weitere (limitierende) Haftungsbestimmungen sind im Punkt 11 der Verkaufs-, und Lieferbedingungen (VLB) www.aspoeck.com zu finden.
- Limitierende Bestimmungen zur Produkthaftung sind im Punkt 12 der Verkaufs-, und Lieferbedingungen statuiert (VLB) www.aspoeck.com.

General information:

- National mounting, installation and operating regulations must be observed.
- The product may only be used in accordance with the enclosed instructions and safety notes. Instructions can be found online at www.aspoeck.com.
- No modifications may be made to the product unless only the original spare parts intended for this purpose or spare parts approved by Aspöck are used and installed by professionally qualified personnel.

Exclusion of warranty:

- Warranty for any product damage is excluded in the event of non-compliance with the instructions and information given in these installation instructions and in the product data sheet, in the event of use outside of that intended, outside the intended purpose or outside the intended operating conditions.
- The warranty also does not cover products that have been damaged or are in poor operating condition due to hazards (including environmental hazards, road traffic hazards, hazards caused by third parties or circumstances beyond the control of Aspöck).
- Repair or replacement of a defective product does not result in the start of a new warranty period.
- Other warranty provisions can be found in item 10 of the Terms of Sales and Delivery (TSD) www.aspoeck.com.

Exclusion of liability:

- Aspöck Systems accepts no liability for indirect damage, consequential damage and financial losses.
- Other (limiting) liability provisions can be found in item 11 of the Terms of Sales and Delivery (TSD) www.aspoeck.com.
- Limiting product liability provisions are laid down in item 12 of the Terms of Sales and Delivery (TSD) www.aspoeck.com.



THE ART OF LIGHTS

ASPÖCK Systems GmbH

Enzing 4, 4722 Peuerbach, AUSTRIA

Office: +43 7276 2670-0

E-Mail: office@aspoeck.com



aspoeck.com

